

quality is our top priority

quality handbook

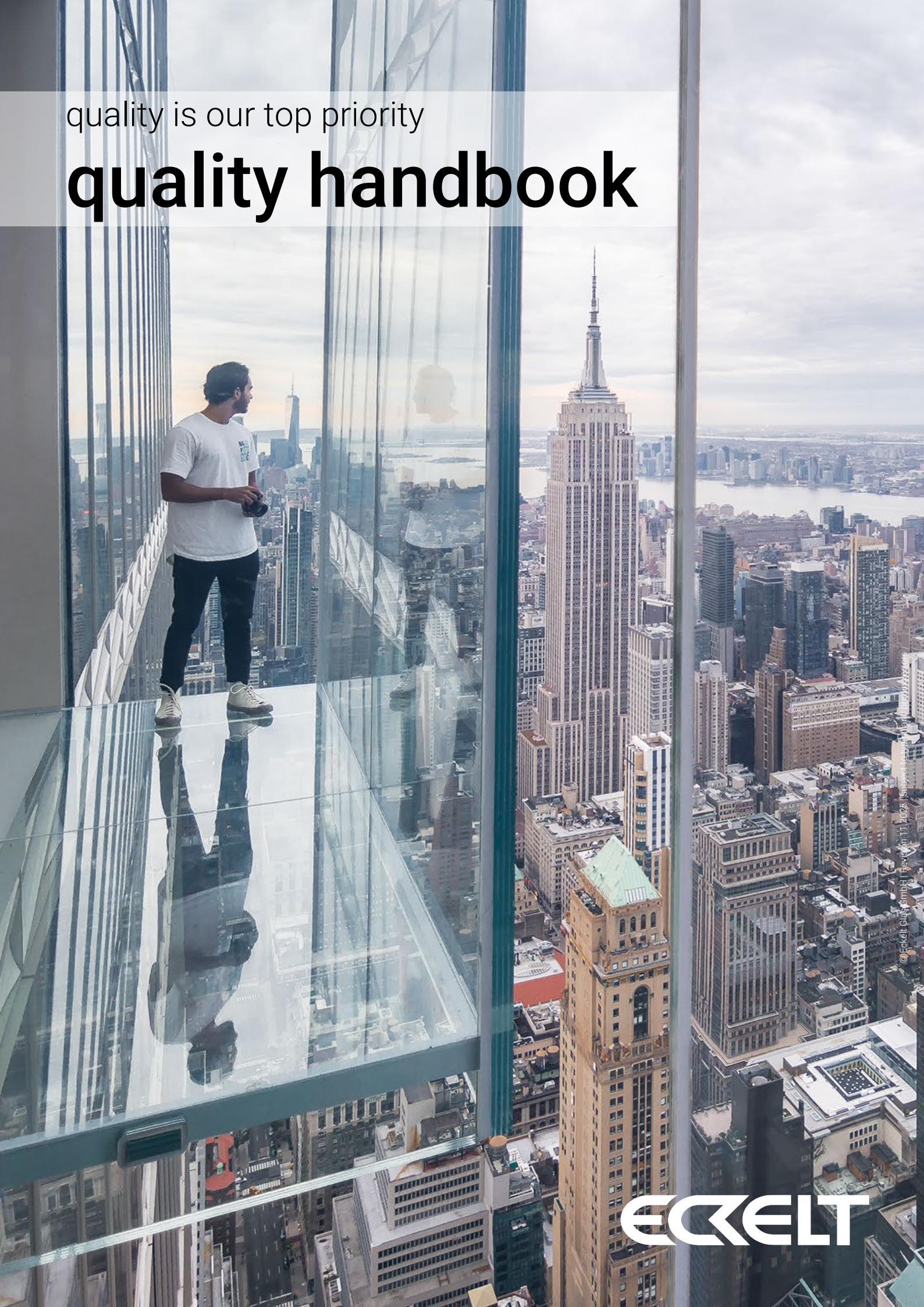

© Eckelt Glas GmbH | Revision 11/2025 | Subject to change without notice

ECKELT

INTRODUCTION

The Eckelt quality handbook defines the tolerances of basic glass, machining and the final products such as tempered safety glass, heat-soak tested tempered safety glass, laminated safety glass and insulating glass.

The basis for its content is provided by the currently valid EN and ÖNORM standards, as described in the different chapters. However, these norms are in practice usually insufficient. This handbook therefore describes the applications that are not (or not clearly) defined in the different standards. In addition, the relevant guidelines for visual evaluation of glasses have been included in this document.

The quality handbook, in its current edition, forms the basis of Eckelt terms of supply and sales.

Eckelt produces as a standard according to this handbook. Any other product requirement is to be agreed with the supplier.

Note

The latest version of the document can be downloaded from <https://www.eckelt.at/downloads>.

The publication of this document supersedes the previously published tolerances.

Instructions for use

The main chapters, 1 to 10, each describe a processing step or a product and are arranged following the production sequence. These chapters are to be used as modules for the different final products.

Example: for a laminated safety glass with polished edges, the following chapters apply:

Chapter 1 – Basic glass

+ Chapter 2 – Cutting

+ Chapter 3 – Processing

+ Chapter 8 – Laminated glass

Standard tolerances

Standard tolerances are tolerances that can be achieved under normal production processes.

Special tolerances

Special tolerances can be achieved with additional measures being taken in production processes. They have to be agreed individually and are possible to achieve at extra cost. Special tolerances shall be specified prior to production and shall only be deemed accepted if they are confirmed accordingly by the contractor.

Measuring equipment

The following measuring devices are used by Eckelt for the control of intermediate and final products:

- Tape measure class II
- Measuring wedge
- Feeler gauge, graduation: 0.02 mm
- Micrometer, resolution: 0.01 mm
- Digital caliper, resolution: 0.01 mm

The tolerances of the measuring devices according to their respective norms have to be taken into account. In case of contention, these tolerances will be deducted from the measurement.

Any control done by the client should be carried out with equivalent measuring devices.

Drawings

For technical reasons customer drawings have to be modified. The dimensions of the glasses are taken over and rounded to whole millimeters.

All the tolerances listed in this handbook apply to the dimensions shown on the Eckelt drawings.

TABLE OF CONTENT

INTRODUCTION	2
TABLE OF CONTENT	4
1. BASIC GLASS.....	6
1.1. Technical tolerances	6
2. CUTTING	7
2.1. Dimensional tolerances	7
2.2. Visual quality.....	9
2.3. Process and product features	11
3. MACHINING.....	12
3.1. Edge machining qualities	12
3.2. Dimensional tolerances	15
3.3. Visual quality.....	19
3.4. Process and product features	19
4. SCREEN-PRINTING AND ENAMEL (“FRIT”).....	22
4.1. Dimensional tolerances	22
4.2. Visual quality.....	23
4.3. Process and product features	27
5. TEMPERED GLASS.....	31
5.1. Dimensional tolerances	31
5.2. Visual quality.....	33
5.3. Process and product features	34
6. LAMINATED SAFETY GLAS.....	36
6.1. Dimensional tolerances	36
6.2. Visual quality.....	38
6.3. Process and product features	41
7. INSULATING GLASS UNITS.....	44
7.1. Dimensional tolerances	44
7.2. Visual quality.....	46
7.3. Process and product features	49
8. SSG – BONDING TOLERANCES AND TOLERANCES FOR THE INTEGRATION OF FITTINGS ...	54
8.1. Thickness tolerance	54
8.2. Bonding tolerances.....	54
8.3. Application of fittings	56

9. DLS ECKLITE®	58
10. VARIO®	59
10.1. Definition.....	59
10.2. Tolerances.....	59
11. GENERAL PRODUCT AND PROCESS FEATURES	62
11.1. Haze.....	62
11.2. Colour differences.....	62
11.3. Wettability of glass surfaces	63
11.4. Condensation on glass surfaces	64
11.5. Subsequent processing of the glasses.....	64
11.6. Subsequently applied films	64
11.7. Coating over-run for external/fixed-sized coatings	65
11.8. Light incidence at the edge of the glass	65
11.9. Recommendation on the maximum temperatures of use	65
12. Example.....	66
12.1. Triple glazing IGU with laminated glas.....	66
12.2. 3-sheet laminated glass.....	67
13. LIST OF TABLES	68
14. LIST OF PICTURES	69

1. BASIC GLASS

Normative references	
ÖNORM EN 572-1	Glass in building – Basic soda lime silicate glass products Part 1 – Definitions and general physical and mechanical properties
ÖNORM EN 572-2	Glass in building – Basic soda lime silicate glass products Part 2 – Float glass
ÖNORM EN 572-4	Glass in building – Basic soda lime silicate glass products Part 4 – Drawn sheet glass
ÖNORM EN 572-5	Glass in building – Basic soda lime silicate glass products Part 5 – Patterned glass

In the norms listed above, the thickness tolerances for the different glass products can be found. Furthermore, the quality requirements as well as the optical and visible defects of the basic glass products are therein described.

1.1. Technical tolerances

The thickness tolerances from the ÖNORM EN 572-2 and ÖNORM EN 572-5 for respectively float and patterned glass are listed below.

Nominal thickness (mm)	Tolerance (mm)
2 - 6	± 0.2
10 - 12	± 0.3
15	± 0.5
19	± 1.0

Table 1: thickness tolerances for float glass according to ÖNORM EN 572-2

Nominal thickness (mm)	Tolerance (mm)
3 - 6	± 0.5
8	± 0.8
10	± 1.0

Table 2: thickness tolerances for float glass according to ÖNORM EN 572-5

2. CUTTING

Normative references	
ÖNORM EN 572-2	Glass in building – Basic soda lime silicate glass products Part 2 – Float glass
ÖNORM EN 572-8	Glass in building – Basic soda lime silicate glass products Part 8 – Supplied and final cut sizes
ÖNORM EN 1096-1	Glass in building – Coated glass Part 1 – Definitions and classification

2.1. Dimensional tolerances

2.1.1. Height, width and squareness

The nominal dimensions for height, H , and width, B , being given, the pane shall not be larger than a rectangle resulting from the nominal dimensions plus allowable tolerance or smaller than a rectangle less allowable tolerance. The sides of the rectangles shall be parallel to one another and these rectangles shall have a common center (see Picture 1). The limits of squareness shall also be prescribed by these rectangles.

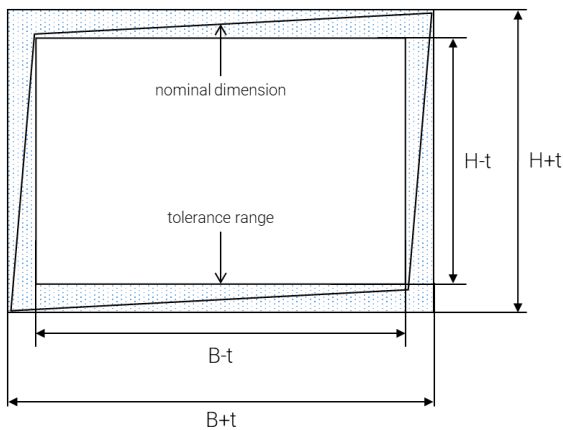

Picture 1: representation of the tolerances

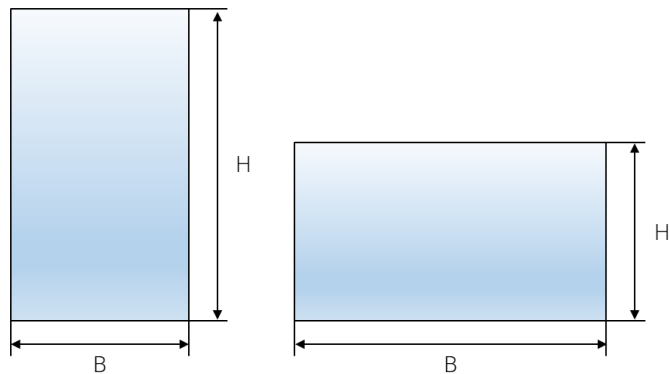

Picture 2: representation of the height and width

General length tolerance (Eckelt Standard)	$\pm 0.2 \text{ mm/lm edge length}$
--	-------------------------------------

2.1.2. Slope-cut

The slope-cut on the glass edges depends on the thickness and characteristics of the basic glass (brittleness, etc.).



Picture 3: under-length



Picture 4: over-length

Glass thickness (mm)	Tolerance t (mm)
2 – 6	± 1
8 – 10	± 1
12	± 2
15	± 3
19	+ 5/- 3

Table 3: tolerance of slope-cut (Eckelt Standard)

This is to be taken into account when stating required tolerances. I.e. for glasses with arrised edges the dimensions can change by twice the slope-cut value.

2.1.3. Diagonal tolerance

Method	Measurement of the diagonals
Measuring device	Tape measure
Tolerance	Difference in length between the two diagonals ≤ 2 mm
Reference	Eckelt Standard

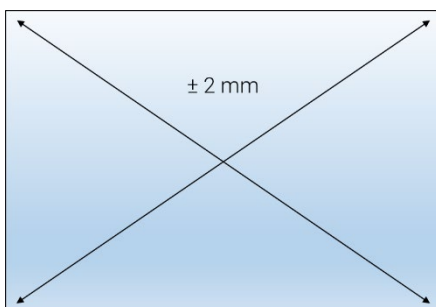

Picture 5: diagonal tolerance

2.2. Visual quality

This part describes the visual quality of monolithic float glass. An exact definition of float glass is given in the ONÖRM EN 572-2.

In case of a coated glass, the visual assessment of the coating is carried out according to ÖNORM EN 1096-1.

For the visual quality of polished wired glass, drawn sheet glass, patterned glass, and patterned wired glass, see ÖNORM EN 572-8.

2.2.1. Conditions of inspection

When checking for defects, the observer must look through the glass, i.e. at the background and not directly at the surface of the glass. Moreover, the defects must not be marked in advance.

The glasses must be observed from the inside to the outside at a distance of at least 3 meters. The viewing angle must be as perpendicular as possible to the glass surface and the observation can last up to 1 minute per square meter. The assessment shall be made with diffuse daylight (e.g. overcast sky), without direct sunlight or artificial lighting.

Glasses which require a control from the outside must be assessed in their final installation situation. The usual viewing distance has to be taken into account, while maintaining a distance of at least 3 meters. The viewing angle must be as perpendicular as possible to the glass surface.

For the assessment of the visual quality, the glass is divided into three sections (see Picture 6):

- R or rebate zone: area of 15 mm width, usually covered by a frame or corresponding to the edge seal in case of a frameless edge.
- E or edge zone: area at the edge of the visible surface with a width of 50 mm.
- M or main zone: the remaining area.

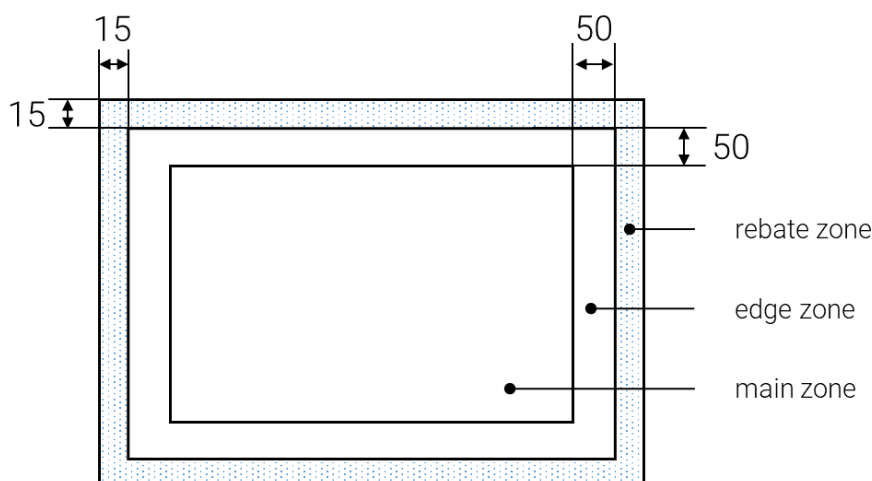

Picture 6: zones for the assessment of visual quality (dimensions in mm)

2.2.2. Acceptance criteria for defects

2.2.2.1. Point-formed defects

Zone	Size of the defect Without halo (mm)	Surface of the glass $S(m^2)$			
		$S \leq 1$	$1 < S \leq 2$	$2 < S \leq 3$	$S > 3$
Rebate zone	all	no restriction			
Edge zone	$\emptyset \leq 1$	permissible if less than 3 defects within a circular area of 20 mm diameter			
	$1 < \emptyset \leq 3$	4	1 per linear edge length		
	$\emptyset > 3$	Not permissible			
Main zone	$\emptyset \leq 1$	permissible if less than 3 defects within a circular area of 20 mm diameter			
	$1 < \emptyset \leq 2$	2	3	5	5 + 2 per additional m^2 above 3 m^2
	$\emptyset > 2$	Not permissible			

Table 4: permissible number of point-formed defects (following the ÖNORM EN 1279-1)

2.2.2.2. Residues

Zone	Type and size of the defect (mm)	Surface of the glass $S(m^2)$	
		$S \leq 1$	$S > 1$
Rebate zone	all	no restriction	
Edge zone	points with $\emptyset \leq 1$	no restriction	
	points with $1 < \emptyset \leq 3$	4	1 per linear m edge length
	stains with $\emptyset \leq 17$	1	
	points with $\emptyset > 3$ and stains with $\emptyset > 17$	1	
Main zone	points with $\emptyset \leq 1$	permissible if less than 3 defects within a circular area of 20 mm diameter	
	points with $1 < \emptyset \leq 3$	permissible if less than 2 defects within a circular area of 20 mm diameter	
	points with $\emptyset > 3$ and stains $\emptyset > 17$	not permissible	

Table 5: permissible number of residues (points and stains) following the ÖNORM EN 1279-1

2.2.2.3. Linear defects

Zone	Individual length (mm)	Sum of the individual lengths (mm)
Rebate zone	no restriction	
Edge zone	≤ 30	≤ 90
Main zone	≤ 15	≤ 45

Table 6: permissible length of linear/elongated defects (following the ÖNORM EN 1279-1)

Hairline scratches are allowed, as long as they do not form a cluster. A hairline scratch is a fine scratch that can't be felt with the fingernail and that can only be seen with a direct incident light.

2.3. Process and product features

2.3.1. Cut-back and break-off for acute angles

For production-technical reasons, Eckelt reserves the right to manufacture corner cut-backs in case of corners with acute angles ($<45^\circ$). The length "x" of the cut-back is given in the Table 7. Should this not be carried out, the surface of the possible cut-back will not be assessed. In this zone irregularities or break-offs may occur at the edges as well as on the surface of the glass. These are no ground for claims.

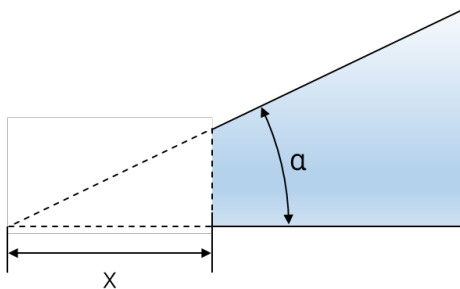

Picture 7: cut-back

Angle α (mm)	Length of the cut-back x (mm)
≤ 12.5°	65 mm
≤ 20°	33 mm
≤ 35°	12 mm
≤ 45°	8 mm

Table 7: length of the cut-back (Eckelt Standard)

3. MACHINING

Normative references	
ÖNORM EN 12150	Glass in building – Thermally toughened soda lime silicate safety glass, part 1 und 2
ÖNORM EN 14179	Glass in building – Heat soaked thermally toughened soda lime silicate safety glass, part 1 und 2
ÖNORM EN 1863	Glass in building – Heat strengthened soda lime silicate glass, part 1 und 2
DIN 1249-11	Glass in building Part 11 – Glass edges – Terms and definitions, characteristics of edge types and finishes

3.1. Edge machining qualities

For technical-production reasons Eckelt reserves the right to deliver an edge quality higher than ordered. Irregularities in the edge quality are to be evaluated according to the ordered quality.

Within one order, the glasses may be processed on different machines for technical reasons (rectangles, shapes, dimensions...). Resulting differences in the visual aspect of the processed edges do not represent a non conformity.

3.1.1. Cut edges (KG)

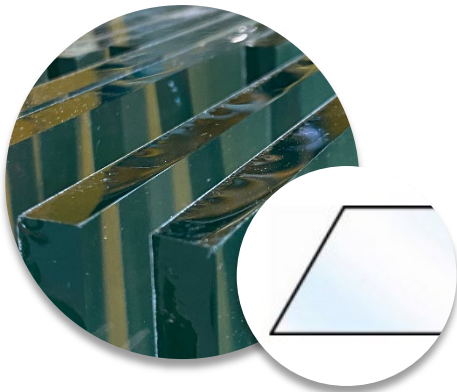

A cut edge is an unprocessed edge created when cutting a float glass. Its edges are sharp. Slight wave lines occur perpendicular to the edges. Generally, the cut edge is broken flat. However, it is possible that irregular breaks may occur particularly for thick glasses and non-linear shaped sheets.

3.1.2. Arrissed edges (KGS)



An arrissed edge is a cut edge which edges have been smoothed.

3.1.3. Edges fine internal

A glass ordered with arrised edges is ground for production-technical reasons. The quality requirement corresponds to those of KGS.

3.1.4. Ground-to-size edges (KMG)

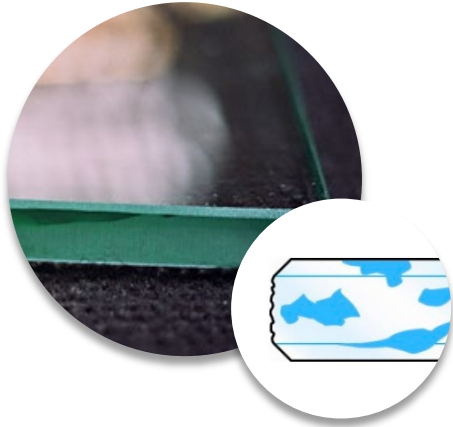

The glass sheet is brought to the desired dimensions by grinding the surface of the edge. The edges ground to size can be produced with cut edges (corresponding to arrised edges). Blank areas and flakes are permissible.

3.1.5. Flat smooth ground edges (KGN)

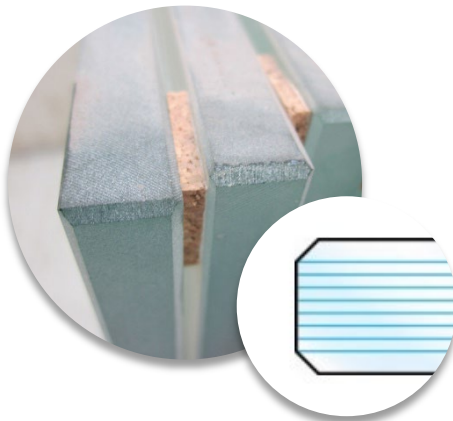

The surface of the glass edge is completely machined. The ground edge has a matte/frosty appearance. Blank areas and flakes are not permissible.

3.1.6. Polished edges (KPO)

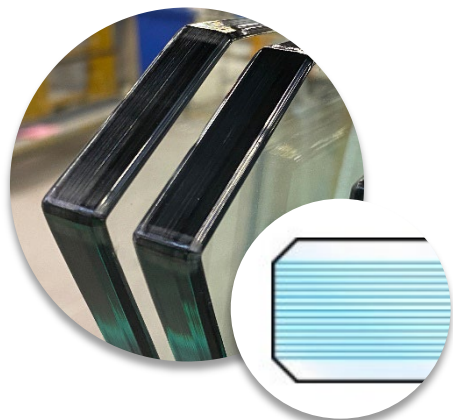

A polished edge is an over-polished ground edge. Matte areas are not permissible. Polishing marks that can be seen and felt are permissible.

3.1.7. Polished edges internal

A glass ordered with ground edges is polished for production-technical reasons. The quality requirements correspond to those of KGN.

3.1.8. Beveled edge (GK)

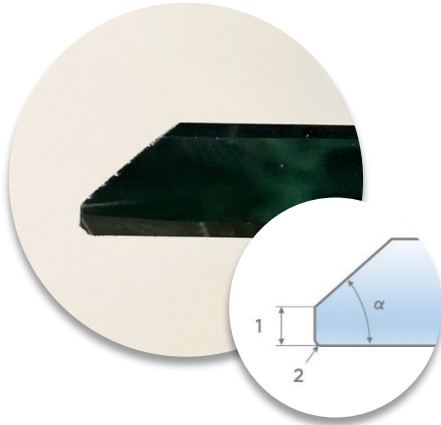

The beveled edge forms an angle $30^\circ < \alpha < 90^\circ$ with the glass surface and runs out onto a residual edge perpendicular to the glass surface.

3.2. Dimensional tolerances

3.2.1. Length and width

For arrised edges the tolerances defined in [Cutting - 2.1. Dimensional tolerances](#) apply (including slope-cut tolerances).

For ground or polished edges the tolerances given in Table 8 apply. They depend on the glass thickness d and are valid for both rectangles and shapes.

Edge length (mm)	Tolerance (mm)	
	$d \leq 12$ mm	$d \geq 15$ mm
≤ 3000	+ 1.0/- 3.0	+ 1.0/- 4.0
≤ 6000	+ 1.0/- 4.0	+ 1.0/- 5.0
≤ 8000	+ 1.0/- 5.0	+ 1.0/- 6.0

Table 8: length and width tolerance for ground or polished edges (Eckelt Standard)

3.2.2. Diagonal difference for rectangle

The permitted difference between the two diagonals in mm is given by $1.42 \times$ edge length (longest edge in m).

Example

2.3 m edge length $\rightarrow 1.42 \times 2.3 = 3.3$ mm $\rightarrow 3$ mm diagonal tolerance

In case of edge processing, the break-off described in the paragraph [2.3.1. Cut-back and break-off for acute angles](#) is to be taken into account.

3.2.3. Shells for cut or arrised edges

Shells that do not reduce the glass thickness d of an individual pane by more than 15% are permitted. The maximal radius of the shell must not exceed 3 mm.



Picture 8: shells

3.2.4. Chamfer tolerance for ground, flat ground or polished edges

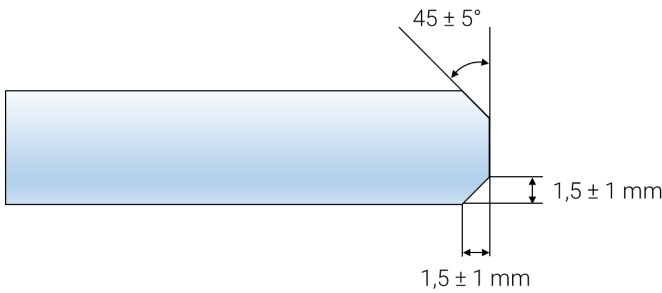

Picture 9: chamfer tolerance for edge machining (Eckelt Standard)

3.2.5. Beveled edge tolerances

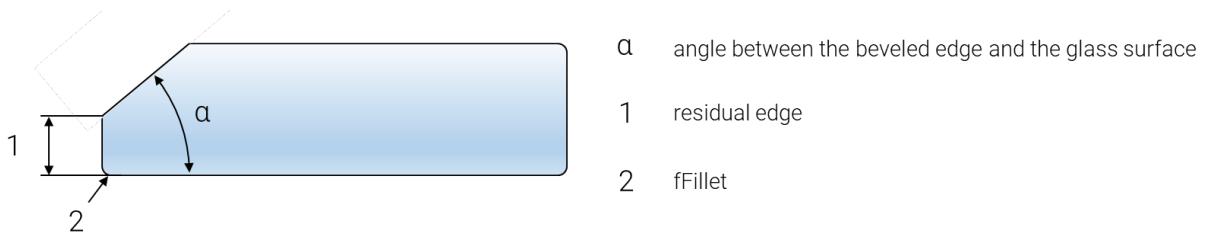

Picture 10: beveled egde

Angle tolerance (Eckelt Standard)	$\pm 3^\circ$
-----------------------------------	---------------

3.2.6. Machining operations

Machining operations can be corner cut-off, corner cut-out, edge cut-out or cut-out in the body of the glass. The position, dimensions and feasibility of the machining operations must be individually validated. The hole positions or position tolerances of the machining operations correspond to the edge machining tolerances.

3.2.6.1. Ground or polished corner cut-offs

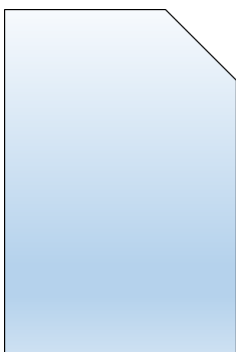

Picture 11: corner cut-off

Corner cut-off will be considered as shapes. Therefore, the edge machining tolerances given in the Table 8 apply.

3.2.6.2. Ground or polished cut-out in the body, edge and corner cut-outs

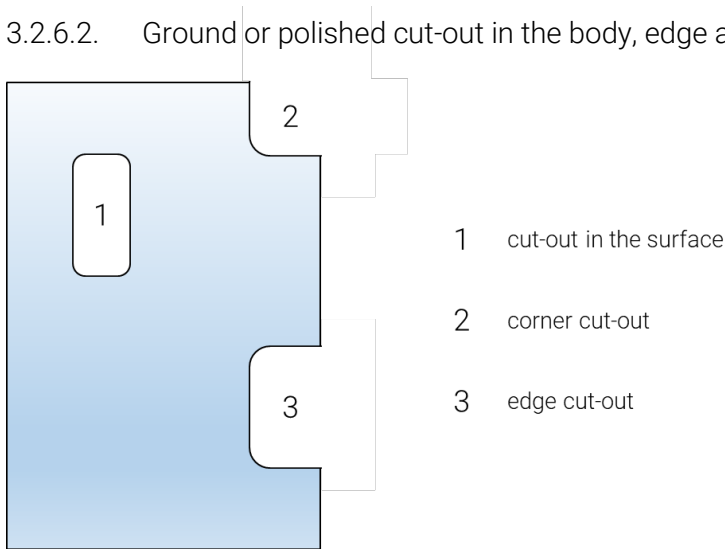

Picture 12: different types of cut-outs

Position tolerance	± 3 mm based on the reference corner defined in Eckelt drawings
Dimension tolerance	± 2 mm

Table 9: tolerances of cut-outs (Eckelt Standard)

3.2.7. Boreholes

3.2.7.1. Borehole diameters

3.2.7.1.1. Cylindrical holes

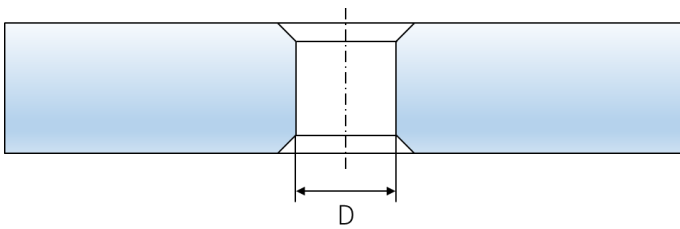

Picture 13: cylindrical holes

Diameter D (mm)	Tolerances (mm)
$D \leq 30$ mm	± 1.0
$D \leq 60$ mm	± 2.0
$D > 60$ mm	considered as cut-out in the surface for the tolerances, see Table 9

Table 10: tolerance of cylindrical holes (Eckelt Standard)

3.2.7.1.2. Countersunk holes

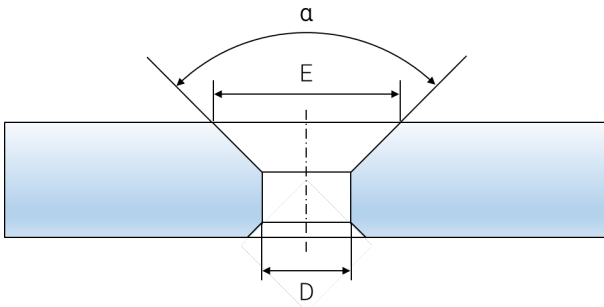

Picture 14: countersunk hole

Diameter D (mm)	Tolerance (mm)
$D \leq 30$ mm	± 1.0
$D \leq 60$ mm	± 2.0

Table 11: core diameter tolerances for countersunk holes (Eckelt Standard)

Tolerances	
Countersink diameter E	+ 1.5/-1.0 mm
Countersink angle α	$\pm 2^\circ$
Minimum glass thickness for countersunk holes	$(E-D)/2 + 2$ mm

Table 12: tolerances of countersunk holes (Eckelt Standard)

3.2.7.2. Position of the hole

The position of the hole is measured in cartesian coordinates (X- and Y-axis) from the reference point to the center of the hole. The reference point is in general an existing corner or an assumed fixed point. The position of the hole (X;Y) is $(x \pm t; y \pm t)$, where x and y are the required distances and t is the tolerance.

Distance to the reference point x or y (mm)	Tolerance t (mm)
≤ 3000	± 2.0
≤ 8000	± 3.0

Table 13: position tolerances for holes (Eckelt Standard)

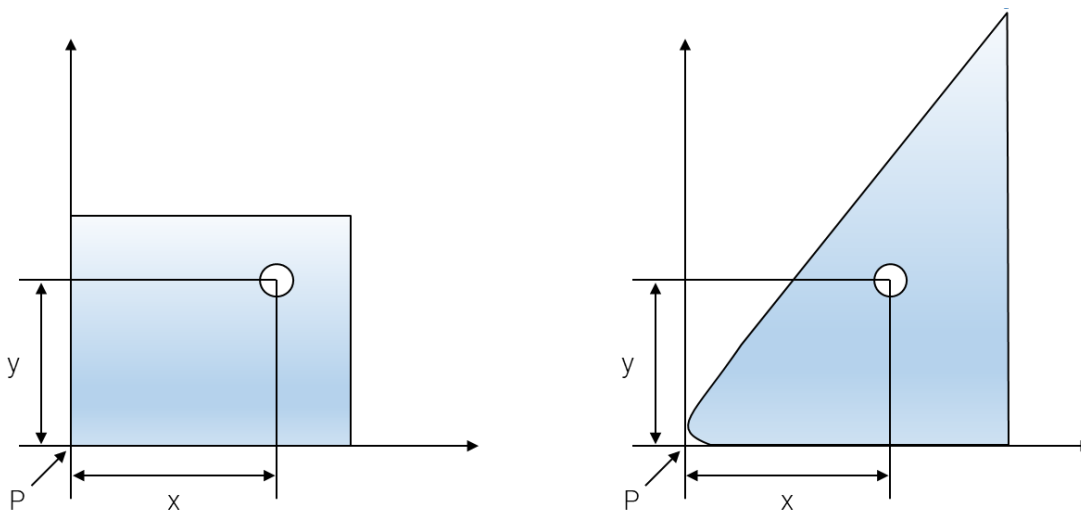

Picture 15: examples for the position of holes based on a reference point

3.3. Visual quality

For the visual quality of machined glass, see chapter [Cutting – 2.2. Visual quality](#).

3.4. Process and product features

3.4.1. Dubbed corners

A dubbed corner is obtained by grinding down the sharp edge at the corner of the glass after the edge machining operations. A dubbed corner has a matt appearance.

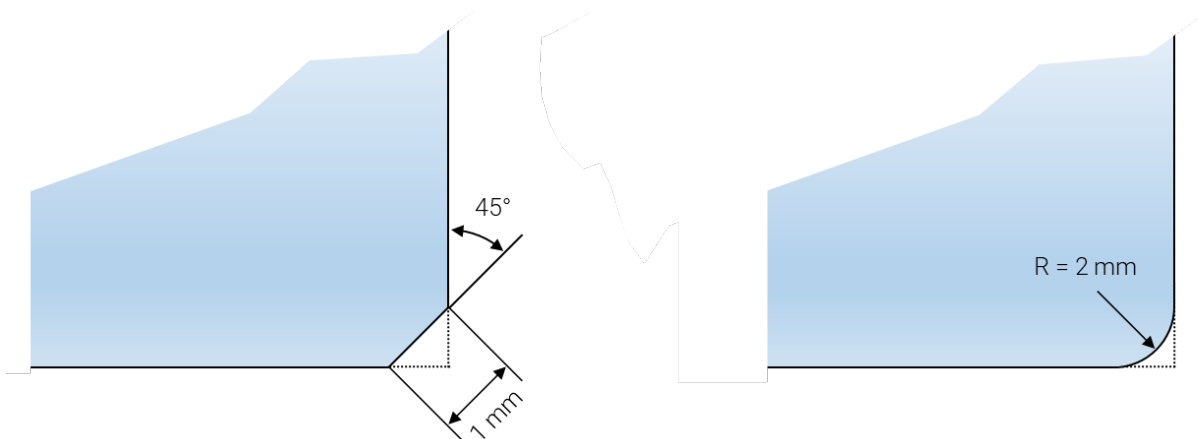

Picture 16: dubbed corner

For technical production reasons, the dubbed corner may vary as shown in Picture 16 (1mm/45° or $r=2$ mm) or may not be present. This does not constitute a reason for claim.

3.4.2. Cut-outs

Within one order, the glasses may be processed on different machines for technical reasons (rectangles, shapes, dimensions...). Resulting differences in the visual aspect of the processed edges do not constitute a ground for claim.

For technical reasons the internal corners will be processed with a minimal radius of 10 mm.

The cut-out must not exceed $\frac{2}{3}$ of the corresponding edge length. In case of an edge cut-out, $\frac{1}{3}$ of the edge length must remain on both sides of the cut-out.

3.4.3. Boreholes

3.4.3.1. Visual aspect

Within one order, the glasses may be processed on different machines for technical reasons. Resulting differences in the visual aspect of the holes do not constitute a ground for claim.

3.4.3.2. Restriction on the borehole diameter

The borehole diameter D should not be smaller than the glass thickness.

3.4.3.3. Restrictions on the borehole position

The limitations on hole positions depend on:

- the nominal glass thickness (d)
- the dimensions of the glass pane (B, H)
- the hole diameter (D)
- the shape of the glass pane
- the number of holes

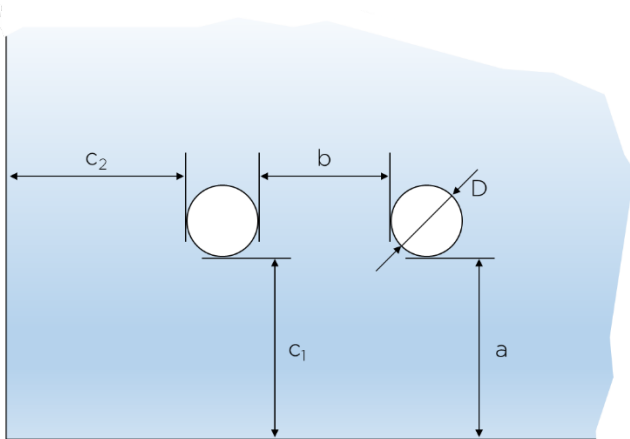

Picture 17: position of the holes

Distance	Restrictions			
	d = 4 – 6 mm	d = 8 – 12 mm	d = 15 mm	d = 19 mm
Min. hole diameter D	$D \geq d$	$D \geq d$	$D \geq 18 \text{ mm}$	$D \geq 25 \text{ mm}$
Distance edge of a hole – edge of the glass a	$\geq 2d$	$\geq 2d$	$\geq 30 \text{ mm}$	$\geq 40 \text{ mm}$
Distance between the edges of two holes b	$\geq 2d$	$\geq 2d$	$\geq 45 \text{ mm}$	$\geq 60 \text{ mm}$
Distance edge of a hole – corner of the glass c_1	$\geq 2d$	$\geq 2d$	$\geq 45 \text{ mm}$	$\geq 45 \text{ mm}$
Distance edge of a hole – corner of the glass c_2	$\geq 2d$	$\geq 2d$ $\geq 2d + 5 \text{ mm}$ (see below)	$\geq 30 \text{ mm}$	$\geq 60 \text{ mm}$

Table 14: restrictions on the position of a borehole (Eckelt Standard)

For a glass thickness from 8 mm to 12 mm the drilled holes in corner areas (distance between the glass corner and center of the hole < 50 mm) must be positioned asymmetrically (min. 5 mm difference between x and y distances). When this is not possible, the holes must be slotted due to an increased risk of breakage during tempering.

If the minimal distances given in the Table 14 cannot be respected, the holes must be slotted.

4. SCREEN-PRINTING AND ENAMEL (“FRIT”)

Normative references / guidelines

BF-Bulletin 015

Guideline to assess the visual quality of enameled glass

Note: Enameled (“Fritted”) glasses are only printed with anorganic paints and can only be manufactured as toughened safety glasses or heat strengthened glasses.

4.1. Dimensional tolerances

Description	Tolerance
Enamel position tolerance ¹ (a in Picture 18)	Pane size ≤ 2000 mm: ± 2.0 mm Pane size > 2000 mm: ± 3.0 mm Pane size > 2000 mm: ± 4.0 mm Minimum KGN edge working (flat smooth ground edge)
Dimensional tolerance for partial enameling (b in Picture 18)	Edge length of printed area: ≤ 1000 mm ± 2.0 mm ≤ 3000 mm ± 3.0 mm > 3000 mm ± 4.0 mm Tolerance range (minimum KGN edge working):
Shape tolerance (c and d in Picture 18)	Depending on size: ≤ 30 mm ± 0.8 mm ≤ 100 mm ± 1.0 mm ≤ 500 mm ± 1.2 mm ≤ 1000 mm ± 2.0 mm > 1000 mm ± 3.0 mm Tolerance range:

¹ The enamel position tolerance is measured from the reference point which must be agreed with the manufacturer.

Table 15: dimensional tolerances for enamel and screen-printing (according to BF-Bulletin 015)

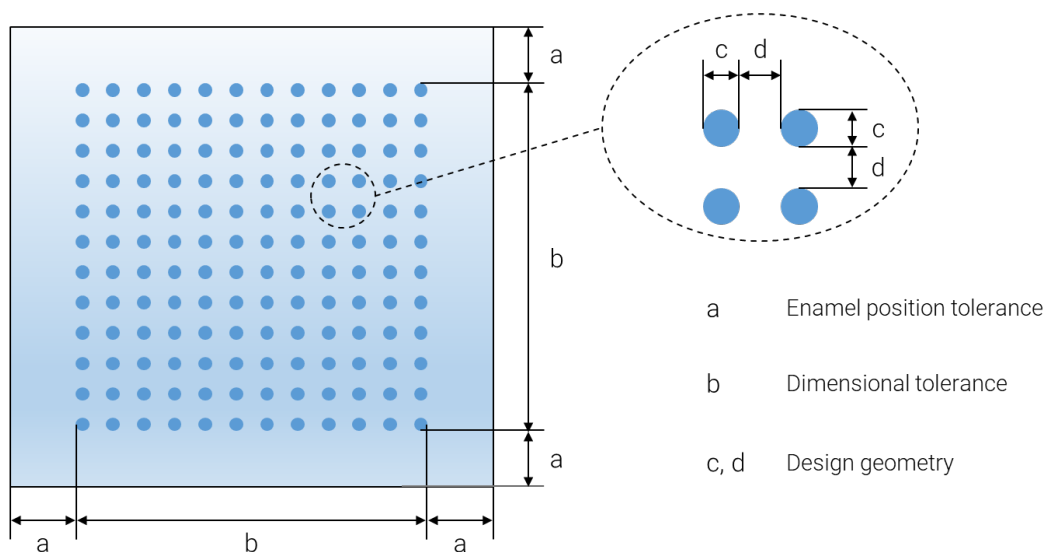

Picture 18: position and design tolerances of printed glass

4.2. Visual quality

4.2.1. Scope

This guideline covers assessing the visual quality of fully or partially enamelled glass where ceramic paint (frit) is applied and fired to produce toughened safety glass (FT) or heat-strengthened glass (HS). This guideline does not cover glass coated with organic paints, nor does it address aspects governed by the building code.

In principle, the notes and tolerances stated in this chapter also apply to other types of paint, e.g. organic paints. However, this guideline does not describe the specific properties of these paint types. Ceramic paints are also used for printing other “painted” glass that can be thermally toughened. This guideline therefore also applies to these products.

If the products are to be properly assessed, the purchase order must clearly indicate the specific area and scope of application, design and visual requirements. This must include the following information in particular:

- indoor and/or outdoor use
- use in vision areas (viewing from both sides, e.g. partitions, shadow boxes)
- application with direct backlighting
- edge quality and absence of paint at the edge (for visible edges a ground or polished edge finish is recommended. For an arrissed version we assume a framed edge is used)
- further processing of the monolithic glass panes to produce e.g. insulating glass units (IGU) or laminated glass/laminated safety glass (LG/LSG) and/or printing oriented towards the interlayer
- printing on position 1 for outdoor application.

If enameled glass sheets are combined into LG/LSG or IGU, each enameled sheet must be assessed individually (as for monolithic glass panes).

This guideline applies to screen-printed glasses with standard design and a print surface of maximum 2800 x 5000 mm. The tolerances for bigger print areas or for Litex Design ID 210, 2146 and 552 must be agreed.

4.2.2. Conditions of inspection

The glass is generally inspected looking through the pane onto the enamel. The defects must not be specially marked. The glass unit must be inspected from a point at least 3 m from and perpendicular to the glass surface, or at a max. 30° viewing angle from the perpendicular. Inspections are carried out under diffuse daylight conditions (e.g. overcast sky) without direct sunlight or artificial lighting against a single-colour opaque background. If any special applications have been agreed in advance, these must be used as inspection conditions.

For laminated glass or laminated safety glass, in addition to the position and design tolerances, any applicable tolerance resulting from offset must be considered.

The present guideline relates exclusively to assessing the enameling of the visible area of the glass in its installed condition.

4.2.3. Acceptance criterias for defects

Defects $\leq 0.5\text{mm}$ ("starry sky/pearl line" or "pinholes" = very small enamel defects) are permitted and normally not considered. Repair (touch-up) of defects using enamel paint before toughening is permissible.

Defecte type	Permissible defects
Punctual defects in the enamel (Eckelt Standard)	max. 3 defects, none of which $\geq 25\text{ mm}^2$ sums of the defect surfaces: max. 25 mm^2
Hairline scratches and baked-in contamination	permitted up to 10 mm length
Clouding ¹	not permissible
Water marks	not permissible
Colour overrun at the edges	Permissible in framed panes and for holes provided with additional mechanical brackets or covers, otherwise not admissible. In unframed panes with ground or polished edge: <ul style="list-style-type: none"> • roller coating: permissible on the chamfer, not permissible on the edge • curtain coating: permissible • screen-printing: not permissible • digital printing: not permissible
Unprinted glass border	permitted up to 2 mm (minimum KGN edge working)
Linear structures in the print	permitted
Colour variations ² (Eckelt Standard)	Colours are assessed through the glass (enamel paint on position 2). Colour variations in a range of $\Delta E \leq 2,9$ with the same glass thickness are permissible (see also section 4.2.4.).

¹ In the case of fine decors (grid pattern with sections smaller than 5 mm) a "moiré" effect can occur. This must therefore be agreed.

² The colour variation tolerances for enamel paint on side 1 are given in the [section 4.2.4.4.](#)

Table 16: visual quality of enameled glass

The following notes apply to geometric figures or so-called aperture masks with a size below 3 mm or progressions from 0 – 100 %:

- The human eye is very sensitive to dots, lines or figures of this size lined-up close together.
- Tolerances in the geometry or spacing in the tenth of a millimeter range will therefore appear to be major variations.
- The feasibility of such applications must therefore always be agreed. We recommend producing a 1:1 sample.

4.2.4. Assessment of the colour impression

Colour variations cannot generally be ruled out, as they can be caused by several unavoidable factors.

Due to the factors listed below, there might be a recognisable colour difference between two enameled glass panes under specific light and viewing conditions, which the observer might subjectively assess as 'irritating' or 'not irritating'.

4.2.4.1. Type of basic glass and influence of the colour

The intrinsic colour of the glass, which depends substantially on the glass thickness and the type of glass (e.g. body-tinted glass, low-iron glass etc.), gives rise to a change in the colour impression of the enamel (with enamel on position 2). Furthermore, different coatings may have been added to this glass, such as solar control coatings (increase of the light reflection of the surface) or reflection-reducing coatings, or the glass can be slightly embossed, e.g. structured glass. Colour variations in the enameling cannot be ruled out, due to fluctuations during paint manufacture and the firing process.

4.2.4.2. Type of light during the observation

The light conditions change continuously depending on the season, the time of day and the prevailing weather. This means that the spectral colours of the light which are transmitted through the various media (air, first surface, glass body) and strike the paint are present to varying degrees in the visible spectral range (380 nm – 780 nm).

The first surface already reflects part of the incident light, depending on the angle of incidence. The "spectral colours" striking the paint are partially reflected or absorbed by the paint (pigments). As a result, the colour appears different depending on the light source, the position from which it is viewed and the background.

4.2.4.3. Observer or viewing conditions

The human eye reacts to different colours in very different ways. While we perceive a very minor colour difference in shades of blue clearly, we perceive colour differences in shades of green less clearly.

Tolerances for colour consistency in prints on glass should be specified in such a way that any colour variations can be barely detected by an observer under normal conditions. No specific standards have been firmly established here.

The tolerances are a compromise between productivity and the requirement for the glass units in a building to make a good visual impression under normal installation conditions. The colour impression may also vary from paint manufacturer to paint manufacturer, despite being the same colour (as defined by colour codes such as RAL, NCS, etc.).

Given the variation in natural light, the position of the observer in terms of viewing angle and distance, the ambient colour, the colour neutrality and surface reflectance, the tolerance values may only be used as a general guide. All on-site circumstances should be considered individually for each relevant building – in particular the building in its specific surroundings.

Colours are shown for a production check objectively using the CIE L*a*b* system, based on the standardised D65 reference light and a 10° viewing angle. The desired position in the a, b colour coordinate system and the lightness characterised by the letter L, are subject to minor fluctuations

resulting from the production process. If the customer requires an objective benchmark for evaluating the colour coordinates, the procedure for this must be agreed with the manufacturer in advance.

The general course of action is defined as follows:

- Providing samples of one or more paints
- Selection of one or more paints. Specification of tolerances for each paint in consultation with the customer. The underlying measurement values must be determined using glass-specific colour measuring equipment, under identical conditions (identical colour system, light type and geometry, and the same observer). Feasibility check by the supplier for compliance with the specified tolerance (order volume, availability of raw materials, etc.).
- Manufacture of a 1:1 production sample and approval by the customer
- Production to order within the specified tolerances
- Within a single order only one purchase order should be placed for large quantities of an identical colour rather than using sub-purchase orders.

4.2.4.4. Assessment of the colour impression for a print on the weathered side of the glass (side 1)

The colour system Ferro S1de ONE has been specially developed for decoration of float glass on surface 1. The colours have an increased resistance to chemical and weathering.

The inspection is to take place from the screen-printed side or from both sides if the glass is ordered for a see-through area.

A colour difference of $\Delta E \leq 2.90$ only applies at the time of delivery.

The weathering will cause changes in the colour depending on its shade. Therefore, the following additional colour tolerances are allowable after installation - they are divided into 3 groups:

- Light colours: the proportion of white base colour must represent at least 88% of the mix. E.g. AU2WS (white).
Colour difference $\leq \Delta E = 3.0$ permitted
- Mid-tones: e.g. AU550WS (blue), AU150WS (yellow), AU640WS (green), AU300WS (red), AUM1WS (etched colour)
Colour difference $\leq \Delta E = 5.0$ permitted
- Dark colour: the proportion of black base colour must represent at least 12% of the mix. E.g. AU752WS (grey), AU1WS (black).
Colour difference $\leq \Delta E = 10.0$ permitted

Claims will generally not be acknowledged when, in addition to our general recommendations for cleaning, the following conditions for "printed on weathered glass side - surface 1" are not complied with.

The facade must be cleaned at least twice per year. Should the facade be subject to soiling to a level greater than the normal environmental conditions (e.g. major city center or industrial area), then the printed glass surface is to be cleaned twice per year using an approved abrasive glass cleaner.

The use of acidic cleansers is not permissible.

AU500 WS has a very transparent visual appearance. In addition, it may have a non-uniform coverage due to differing levels of fusion during tempering. Both are characteristics of this colour and are no reasons for claim.

4.3. Process and product features

4.3.1. General

Enamel paint consists of inorganic substances mixed with glass frit. These substances which determine the colour of the paint are subject to minor variations. During the thermal toughening process (for FT, heat-soaked FT-H and HS) the glass frit surrounds the pigments and fuses with the glass surface. The final colour can be seen only after this firing process.

The paints are selected such that they fuse with the glass surface within a few minutes when the glass surface temperature is about 600 – 620 °C. This temperature window is very narrow and cannot always be exactly reproduced, especially with sheets of different sizes and different colours.

Furthermore, the application method is also crucial for the colour impression. Because the paint layer applied is thin, screen printing or digital printing has a lower hiding power than a product manufactured by a rolling method which applies a thicker therefore denser paint layer. The opacity depends also on the paint selected.

The glass sheet can be printed over its full surface or just part of it, using different application methods. As a rule, the enamel is applied to the side which is not exposed to the weather (surface 2). Any exception must be agreed with the manufacturer. Application on surface 1, which is exposed to the weather, requires special paints. These ceramic (enamel) paints are largely scratch-resistant and to a certain extent acid-resistant; their light-fastness and adhesion durability are equivalent to the durability of ceramic fused-on paints.

Full surface enamelling with translucent paints may cause clouding or stripes. These characteristics can be detected visually by backlighting the panes. It should be noted that any medium attached directly to the painted rear side (such as sealants, panel adhesive, insulation, or a brackets) may show through the translucent paint.

When using metallic paints, it must be ensured that they are not exposed to humidity. Use of these paints must be agreed.

If printed sheets are coated with additional functional layers, perhaps for solar control or thermal insulation, they must comply with relevant standards and guidelines for assessing the visual quality of the final product. These could include ÖNORM EN 1096 and/or the guidelines for glass in building mentioned above. The printed surface will be assessed based on the present guideline. If printing is used to cover e.g. the profiles of bonded facades, the structure may be visible through very light colours. Suitable colours must be used for this. Furthermore, if the printed surfaces are to be bonded, the compatibility and adhesion of the printed surfaces with the adhesive must be checked, among other things. Separate testing may also be necessary if printed surfaces are used in structural sealant glazing facade systems.

4.3.2. Types of process

4.3.2.1. Rollercoating

The flat glass pane passes beneath a ribbed rubber roller which transfers the enamel paint onto the surface of the glass. This ensures a regular, even and homogeneous paint distribution over the entire surface. Typically, the ribbed pattern of the roller is visible if the pane is examined close up (from the enameled side). However, these 'ribs' are usually barely visible when the glass is viewed from the front (looking through the pane). Rolled enamel glass is generally not suitable for use in vision areas. Such use must always be agreed in advance. A "starry sky" effect (numerous very small imperfections or pearl lines) may appear in the enamel.

Due to the nature of this manufacturing process a "colour overrun" is possible on all edges of the pane. This overrun may be slightly corrugated especially on the long edges (viewed in the direction in which the roller unit moves). However, the edge surface usually remains paint-free. If paint-free visible edges are explicitly required, this must be specified in the purchase order. For this reason, the installation position should be agreed in advance. The enamel paint can be optionally applied using a spray gun.

4.3.2.2. Manual rolling

Depending on the production enamel paint can also be manually applied using a lambswool roller (Designation: LM). This type of order is mainly used for glass with enamel borders. Clouding, hazing and shadows in paint coverage as well as an inhomogeneous appearance in transmission cannot be avoided.

4.3.2.3. Screen printing

Unlike the methods described above, with screen printing the surface can be fully or partially coated. The paint is applied to the glass surface on a horizontal screen-printing table through a narrow-mesh screen using a squeegee blade. The thickness of the applied paint depends on the mesh width of the screen and the thread diameter. The paint layer is generally thinner than with roller coating and curtain coating. Depending on the colour chosen it appears either opaque or translucent.

This manufacturing process is characterised by slight streaks, both in the direction of print and across it, as well as by occasional spots of haze, depending on the paint used. As a rule, the edges of the glass panes remain free from paint during screen printing but may display a slight beading in the arched area. It is therefore imperative that visible edges are specified to produce the appropriate result compliant to the application.

This process can be used for multi-colour printing such as "double screen printing", where two different colours can be seen depending on the surface being viewed. In this case we should always be consulted on issues of tolerances (e.g. of congruency).

It is possible to print onto selected types of patterned glass, but we must always be consulted in advance.

Please also check or agree the durability and availability of the screen with us if your building project is over a long time period.

4.3.2.4. Digital printing

The ceramic paint is applied directly onto the glass surface using a method similar to inkjet printing. The thickness of the paint layer may vary. The layer deposited by this process is thinner than with roller coating or screen printing, and depending on the colour chosen will appear either opaque or translucent. Unlike screen printing, digital printing offers much higher print resolution.

This manufacturing process is characterised by barely visible streaks in the direction of the print. These cannot be avoided due to the production process. As a rule, the edges of the glass panes remain free from paint during digital printing but may display a slight beading in the arched area. It is therefore imperative that visible edges are specified to produce the appropriate result compliant to the application.

The print edges are exactly straight in the direction of print and slightly serrated across the direction of print. There may be paint spray mist along the printed edges. With dot, hole and text motifs, the printed edges display a serration which, like the spray mist, is only visible if viewed close up.

Digital printing is best suited for complex multi-colour grid designs or images and less suited for monochrome full-surface printing.

4.3.3. Moiré-Effect

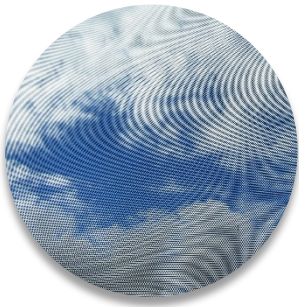

Depending on the pattern, a “moiré” effect may occur in motifs applied by screen printing. The moiré effect (from French moirer “clouding, marbling”) becomes apparent if regular fine grids are overlaid with additional, apparently coarse grids. Their appearance is similar to the patterns caused by interference. This is a physical effect and is no grounds for any claim.

4.3.4. Half-moon effect for screen-printing

The half-moon effect is a curved line that can sometimes appear on ceramic screen-printed glasses. This is a consequence of the screen-printing process and is not considered as a defect.

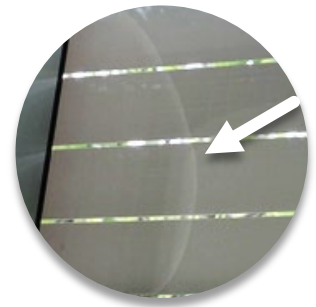

4.3.5. Ghost images for screen-printing

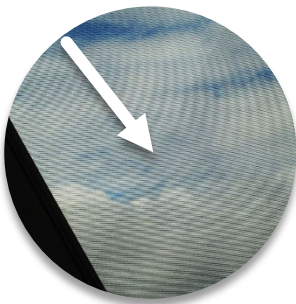

If different shapes and sizes are printed with the same screen, silhouettes of the previously printed panes may be visible as lines or surfaces. This effect does not constitute a defect.

4.3.6. Partial enamel in laminated glass

The feasibility of glasses with partial enamel in contact with the interlayer must be checked with us.

4.3.7. Enamel / screen-printing on ornament glasses

Printing on ornamental glasses is possible but must be in any case clarified with us.

4.3.8. Etch coloured screen-printing

In case of etch coloured screen-printing in contact with the interlayer, we recommend first reviewing a full-size sample before final ordering.

4.3.9. Metallic colours

Metallic colours may, as a result of the manufacturing process and pigmentation, lead to obvious differences in colour-rendition, which does not allow a uniform appearance of adjacent glass units. This product-specific characteristic of metallic paints creates a lively facade appearance even when viewed at differing angles.

5. TEMPERED GLASS

Normative references	
ÖNORM EN 12150	Glass in building – Thermally toughened soda lime silicate safety glass, part 1 und 2
ÖNORM EN 14179	Glass in building – Heat soaked thermally toughened soda lime silicate safety glass, part 1 und 2
ÖNORM EN 1863	Glass in building – Heat strengthened soda lime silicate glass, part 1 und 2

In this chapter the term “tempered glass” will be used to describe the following products:

Generic term	Abbreviation
Thermally toughened safety glass	FT
Heat-strengthened glass	HS
Heat soaked thermally toughened safety glass	FT-H

Table 17: tempered products

Note: All glasses tempered by Eckelt are horizontally tempered.

5.1. Dimensional tolerances

5.1.1. Distortion – valid for float glass

5.1.1.1. Condition of the measure

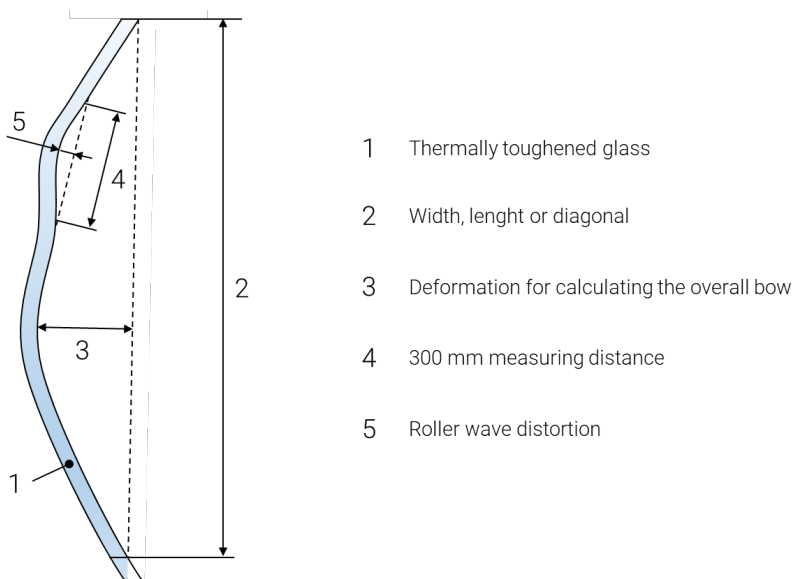

Picture 19: representation of the overall bow and the roller wave distortion

The overall bow shall be measured along the edges of the glass and across the diagonals. The support conditions of the glass for the measurement of overall bow are represented on the Picture 20. The assessment is based on the properties of the primary products.

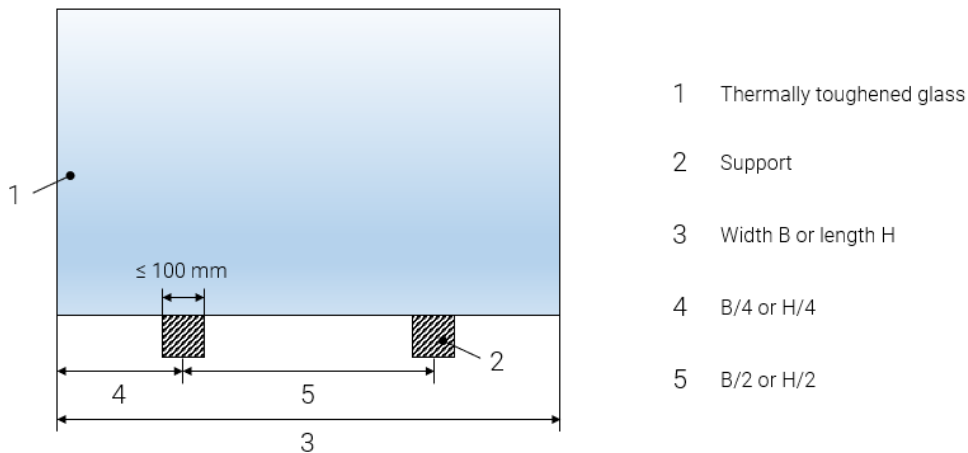

Picture 20: support conditions for the measurement of overall bow

The rollerwave distortion measurement must be performed at least 150 mm away from the glass edge.

5.1.1.2. Tolerances

The following tolerances only apply for a maximum, aspect ratio of 1:10.

Type of distortion	Tolerance
Overall bow	3 mm/m
Rollerwave distortion	0.3 mm/300 mm

Table 18: tolerances for the overall bow and rollerwave distortion (Eckelt Standard)

Note: Square glass panes with an aspect ratio between 1:1 and 1:1.3 and thin glass panes ($\leq 6\text{mm}$) will be subject to a greater distortion than small rectangular sheets.

5.1.2. Edge lift



Picture 21: area for the measurement of the edge lift

The glass shall be placed on a flat support with the edge left overhanging the edge of the support by between 50 mm and 100 mm. A 300 mm ruler is placed on the peaks of the roller waves and the gap between the ruler and the glass is measured using a feeler gauge.

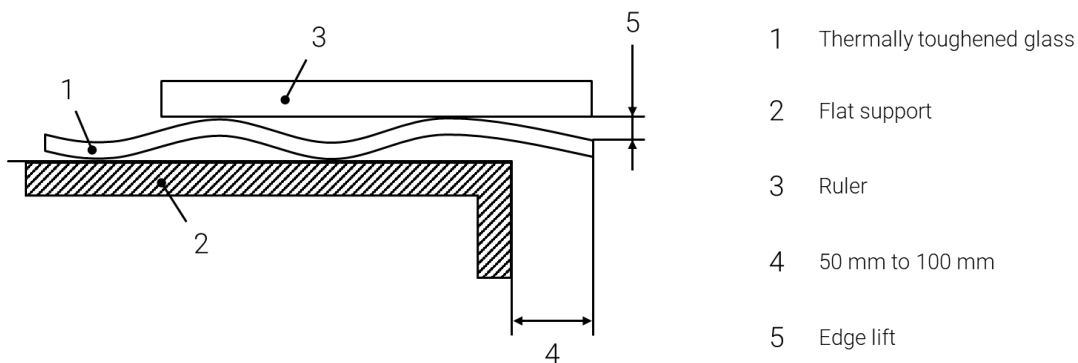

Picture 22: measurement of the edge lift

Type of distortion	Tolerance
edge lift	0.3 mm

Table 19: edge lift tolerance (Eckelt Standard)

5.2. Visual quality

For the visual quality of tempered glass, see chapter [Cutting – 2.2. Visual Quality](#).

5.3. Process and product features

5.3.1. Optical distortion



Process-related deformations cause an optical deformation, which is normally visible in reflection. Glasses thicker than 8 mm may incur small indentations on their surface (“roller pick-ups” or “roller-marks”).

5.3.2. Anisotropy

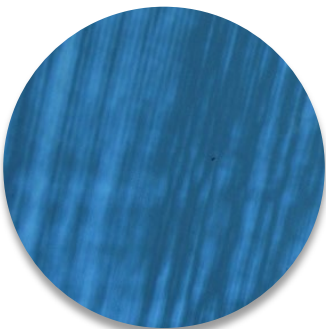

Tempering creates zones of varying stress in the cross-section of the glass. These stress patterns cause a birefringent effect in the glass, which is visible when viewed in polarized light. These areas show up as coloured zones, sometimes referred to as “leopard spots” or “polarized fields”. Polarized light is present in normal daylight.

Its amount depends on the weather and the position of the sun. The haze and bi-refrigrant effects are more noticeable at glancing angles or through polarized glasses. Anisotropy is not considered a defect, but a visible effect.

5.3.3. White Haze

During the tempering process, white stripes may appear on the surface of the glass. These must be evaluated according to the conditions of inspection of the respective products. The white stripes are ceramic abrasion from the furnace rollers that are in contact with the glass during the tempering process. This abrasion can be permanently removed with little effort (polishing with a felt wheel).



5.3.4. Heat-Soak Test

The heat-soak test reduces the risk of spontaneous breakage due to nickel sulfide inclusions in the tempered glass. However, as mentioned in the ÖNORM EN 14179-1, this risk can not be completely eliminated.

The heat-soak test is performed according to the ÖNORM EN 14179 part 1 and part 2. Other (country specific) requirements must be agreed in advance.

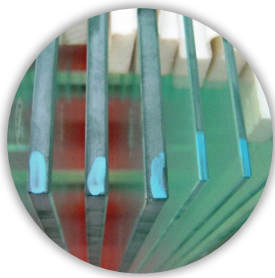

*marking
before Heat-Soak-Test*

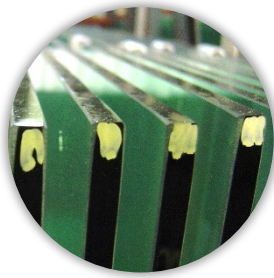

*marking
after Heat-Soak-Test*

Eckelt marks the edge of heat-soaked glasses with a thermochromic marker. This marking serves as proof of testing and is no reason for a claim.

5.3.5. Fragmentation pattern in installed conditions

The fragmentation pattern in installed conditions may not always correspond to the one determined during a breakage pattern test since other stresses may appear in the glass due, for example, to the assembly or to further processing steps (e.g. laminated glass production).

5.3.6. Marking

In addition to the normative regulations for the marking of safety glass, Eckelt reserves the right to affix, modify or change the position of the marking on the glasses, even if these are expressly ordered without permanent marking or with a specific permanent marking. The aforementioned changes do not constitute grounds for claims and therefore cannot lead to the replacement of the glass.

6. LAMINATED SAFETY GLAS

Normative references	
ÖNORM EN ISO 12543-1	Glass in building – Laminated glass and laminated safety glass Part 1: Definitions and description of component parts
ÖNORM EN ISO 12543-5	Glass in building – Laminated glass and laminated safety glass Part 5: Dimensions and edge finishing
ÖNORM EN ISO 12543-6	Glass in building – Laminated glass and laminated safety glass Part 6: Appearance

6.1. Dimensional tolerances

6.1.1. Height and width

The glass pane shall not be larger than the nominal dimensions increased by the plus permissible tolerance or smaller than the nominal dimensions reduced by the permissible minus tolerance.

The tolerances for the width B and the height H are given in the Table 20. Any offset must be included within these tolerances.

Offset tolerances are defined in the chapter [6.1.3. Offset tolerance](#).

If a component of the laminated glass is a tempered glass, an additional deviation of ± 3 mm is permitted.

Nominal dimension B or H (mm)	Nominal thickness of the laminated glass ≤ 8 mm	Nominal thickness of the laminated glass > 8 mm	
		Nominal thickness of every glass pane < 10 mm	At least a glass pane with a nominal thickness ≥ 10 mm
≤ 2000	+ 3.0 / - 2.0	+ 3.5 / - 2.0	+ 5.0 / - 3.5
≤ 3000	+ 4.5 / - 2.5	+ 5.0 / - 3.0	+ 6.0 / - 4.0
> 3000	+ 5.0 / - 3.0	+ 6.0 / - 4.0	+ 7.0 / - 5.0

Table 20: tolerance of the height B and the length H for LSG according to ÖNORM EN ISO 12543-5

6.1.2. Diagonal

The maximum allowed difference between the two diagonals is given in the Table 21.

Nominal dimension B or H (mm)	Nominal thickness of the laminated glass ≤ 8 mm	Nominal thickness of the laminated glass > 8 mm	
		Nominal thickness of every glass pane < 10 mm	At least a glass pane with a nominal thickness ≥ 10 mm
≤ 2000	6	7	9
≤ 3000	8	9	11
> 3000	10	11	13

Table 21: maximum allowed difference between the diagonals of a LSG according to ÖNORM EN ISO 12543-5

6.1.3. Offset tolerance

The individual glass panes may shift during the laminating process.

For laminated safety glasses composed of 2 or more glass panes, the edges of each pane are individually processed.

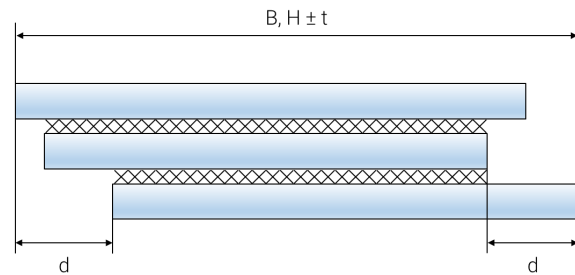

Picture 23: shift tolerances for laminated safety glass

The maximum permitted offset dimension is given in the Table 22. The width B and height H must be considered separately.

For glasses meeting one of the following requirements, the offset tolerance must be agreed.

- aspect ratio > 1:20
- element thickness > 34 mm
- width < 400 mm

Nominal dimension B or H (mm)	Maximum permissible offset d (mm)
≤ 2000	2.0
≤ 3000	3.0
> 3000	4.0

Table 22: maximum permissible offset d according to ÖNORM EN ISO 12543-5

6.1.4. Thickness tolerance

The thickness tolerance of a laminated glass is given by the thickness tolerances of the individual panes (according to ÖNORM EN 572) plus the following additional tolerance depending on the interlayer thickness:

- For every interlayer ≤ 2 mm, an additional tolerance of ± 0.1 mm is added
- For every interlayer > 2 mm, an additional tolerance of ± 0.2 mm is added

Example: A laminated glass composed of 3 float glass panes with a nominal thickness of 6 mm and two interlayers of 0.76 mm each. According to the ÖNORM EN 572-2, the tolerance for a 6 mm float glass is ± 0,2 mm. A tolerance of ± 0,1 mm per interlayer must be added.

$$\text{Nominal thickness} = 3 \times 6 + 2 \times 0.76 = 19.52 \text{ mm}$$

$$\text{Thickness tolerance} = 3 \times 0.2 + 2 \times 0.1 = \pm 0.8 \text{ mm}$$

6.1.5. Overall bow / Local distortion

Deviation in surface flatness (Eckelt standard)	$\pm 3 \text{ mm/lm edge length}$
---	-----------------------------------

The tolerances of the pre-products for local distortion remain in effect.

6.1.6. Countersunk holes in LSG

For laminated glasses with countersunk holes, Eckelt reserves the right to manufacture the cylindrical drilled hole of the rear sheet with a diameter 4 mm greater than the core diameter of the countersunk hole.

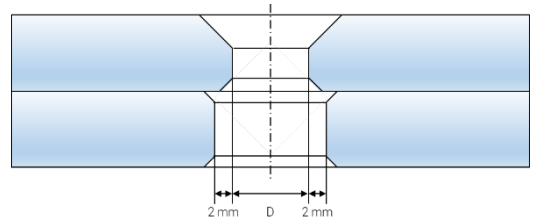

Picture 24: countersunk holes in laminated glass

6.2. Visual quality

6.2.1. Edge quality

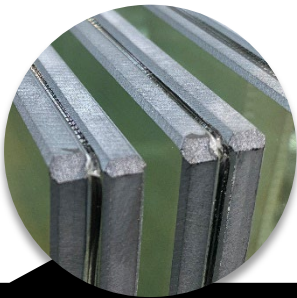

STANDARD

The interlayer is cut with a knife after the autoclave.

FROZEN EDGE

Only for vacuum bagging process. The interlayer edge has a matt, textured appearance.

(Standard for vacuum bagging)

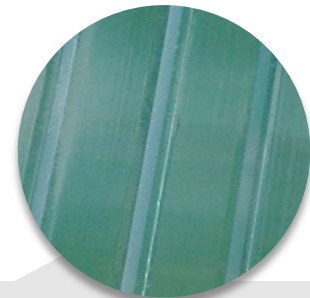
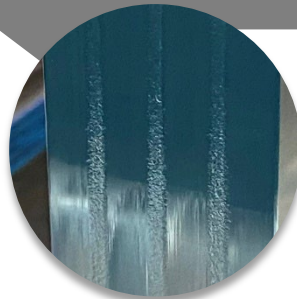

SMOOTH EDGE

Only for vacuum bagging process.

The interlayer edge has an even, smooth and shiny appearance.

(Special process for vacuum bagging)

Visible edges must be specified when placing the order to ensure the best edge quality possible. The interlayer will be compressed on the surfaces of contact between the glass and its support. The phenomenon will be visible and cannot be avoided. If no visible edges are specified interlayer extrusion or shrinkage are allowable. In case of final cut-sized production of laminated safety glass, interlayer protrusions may be present, particularly on the supporting edge.

Protrusions of interlayer are cut after the autoclave with a knife.

6.2.2. Conditions of inspection

The laminated glass is to be evaluated vertically in front of and parallel to a matt grey background, in a diffuse daylight (or equivalent lighting conditions).

The viewer is to stand at 2 meters from the glass and look at the glass at an angle of 90°. The matt background is on the other side of the glass.

- All the defects visible in these conditions will be marked and examined
- Defects smaller than 0.5 mm will be ignored
- Defects bigger than 3 mm are not allowable

The glass pane is to be divided in two areas with different acceptance criterias: the edge area and the vision area (see Picture 25).

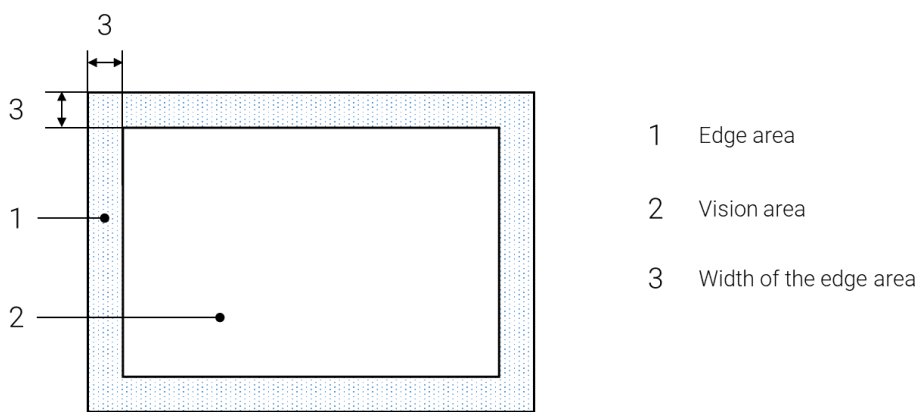

Picture 25: edge and vision area for laminated glasses according to ÖNORM EN ISO 12543-6

Surface of the glass (m ²)	Width of the edge area (mm)
≤ 5	15
> 5	20

Table 23: edge area according to ÖNORM EN ISO 12543-6

Note: If no cut-back is carried out on glasses with acute angles, the surface of the possible cut-back will not be assessed. In this zone irregularities or break-offs may occur at the edges as well as on the surface. These are no ground for claims.

6.2.3. Acceptance criteria for defects

Type of defect		Acceptance criterias
Defects in the edge area in case of framed edges		$\emptyset < 5$ mm or surface of the defect $< 5\%$ of the edge area
Defect in the edge area in case of unframed edges.		Shelling and bubbles are allowable if not visible under the conditions described in the part 6.2.2. Defects in the interlayer: <ul style="list-style-type: none"> • Shrinkage < 2 mm are allowable • Protrusion on the edge have to be cut off
Chips		not allowable
Folds and stripes		Allowable if not visible under the conditions described in the part 6.2.2.
Point-formed defects in the vision area	≤ 0.5 mm	ignored
	> 0.5 mm and ≤ 1.0 mm	no limit as long as there is no cluster of defects ¹
	> 1.0 mm and ≤ 3.0	see Table 25 below
	> 3.0 mm	not allowable
Linear defect in the vision area	Length < 30 mm	allowable
	Length > 30 mm	see Table 26 below

¹ A cluster of defects is when 4 or more defects occur within a distance smaller than 200 mm from each other. This distance reduces to 180 mm in three-sheet laminated glass, to 150 mm in four-sheet laminated glass and to 100 mm in five (or more)-sheet laminated glass.

Table 24: acceptance criteria for defects in LSG according to ÖNORM EN ISO 12543-6

Note: The permissibility of point-formed defects in laminated glass is independent from the thickness of the individual glass panes. The number of allowable defects given in Table 25 is increased by one for every individual interlayer thicker than 2 mm. The number of allowable defects is always rounded up to the next whole number.

Number of monolithic glass panes in the laminated glass	Number of allowable defects depending on the glass surface A (A in m ²)			
	$A \leq 1$	$1 < A \leq 2$	$2 < A \leq 8$	$A > 8$
2	1	2	1/m ²	1.2/m ²
3	2	3	1.5/m ²	1.8/m ²
4	3	4	2/m ²	2.4/m ²
5 and more	4	6	2.5/m ²	3/m ²

Table 25: allowable number of point-formed defects ($1.0 \text{ mm} < d \leq 3.0 \text{ mm}$) in the vision area acc. to ÖNORM EN ISO 12543-6

Glass surface A (m ²)	Number of allowable linear defects with a length > 30 mm
$A \leq 5$	not permitted
$5 < A \leq 8$	1
$A > 8$	2

Table 26: allowable number of linear defects in the vision area according to ÖNORM EN ISO 12543-6

6.3. Process and product features

6.3.1. Edge processing of LSG

In case of laminated glass consisting of two or more glass panes, the edge of each pane can be processed as KG, KGS, KMG, KGN or KPO (see chapter [3.1. Edge machining qualities](#) for more details). The whole laminated glass can also be processed:

- If one of the panes is tempered, an equalization of the edge offset is not possible.
- For a combination of non-tempered glasses, a machining after laminating is possible.

6.3.2. Coloured interlayers

In case of coloured and matt interlayers, the colour intensity is lost over time because due to weathering (e.g. UV exposure). Therefore, subsequent deliveries (e.g. replacement) may present colour differences in comparison with already installed glasses of the same type. This does not constitute a reason for claim.

6.3.3. Colour difference between different LSG interlayers

Due to different formulations in the production of laminated glass interlayers (PVB or Ionoplast), slight colour differences may occur. They occur mostly at the glass edge but can also be seen in the body of the glass.

This colour difference can be seen especially when comparing or using different interlayer types or interlayers with different thicknesses.

This is a product feature which does not constitute a reason for claim.

6.3.4. Laminated glasses with stepped edges

Generally, the interlayer residues must be removed in the stepped edge area. Due to the cutting process, fine scratches can not be avoided.

In laminated glasses with three or more panes where the middle pane(s) is/are recessed to the outer panes, the following points have to be taken into account:

- Depending on the depth and width of the recess, it is not always possible to cut the interlayer residue
- Irregular interlayer protrusions cannot be avoided
- The recess width may vary depending on the overall bow

These points do not constitute a reason for claims. We recommend a technical clarification in advance.

6.3.5. Interaction of laminated glass with humidity/exposed glass edges

Laminated safety glass consists of two or more glass panes with one or more interlayers, usually made of polyvinyl butyral (PVB) or ionoplast.

PVB interlayers are particularly hygroscopic and extremely dry. At the edges of the laminated glass, the PVB interlayer is exposed to the environment. Due to air humidity, standing water and droplet formation, humidity will inevitably penetrate the laminate.

This effect can be intensified by movements of the edge resulting from the tensile forces created between the interlayer and the glass. It will be noticeable after a long period of time in form of clouding or separation of glass and interlayer at the edges (delamination). However, the clouding and the delamination do not lead to any loss of function since the effect is limited to the edge area.

This effect is normally more visible on exposed edges than on glass units mounted in a frame.

6.3.6. Interaction of laminated glass interlayer with other materials

The compatibility of interlayer with other materials used is also extremely important.

To avoid any reactions, the edge of the laminated glass must not come in contact with any sealant, adhesive, plastic or similar materials. Any substance having a direct or indirect contact with the interlayer may cause a chemical reaction that can lead to visual impairments. Depending on its severity, this effect normally has no impact on the safety of the product.

Eckelt recommends carrying out a compatibility test in advance or using products whose good long-term compatibility with interlayer has already been demonstrated.

6.3.7. Laminated glass and edge protection

Based on the current experience, it is not possible to protect the laminated glass edges against the defects described in the parts [6.3.5 – Interaction of laminated glass with humidity](#) and [6.3.6 – Interaction of laminated glass interlayer with other materials](#).

It is often thought that thin layers of varnish or silicone may be used to cover the edges of the glass and the interlayer, thus protecting it. We would like to point out that sealants (e.g. silicone) do not bond with the PVB interlayers and therefore only lie against the material. Moreover, these sealants are not vapor-tight, i.e. humidity could penetrate the system in vapor form despite such preventive measures. It would then become active between this protection and the interlayer, causing discolouration and delamination.

6.3.8. Laminated glass with SentryGlas®

In case of laminated safety glass and LITE-FLOOR with SentryGlas® interlayers, anisotropy-like dark-coloured spots, stripes or rings may be visible under certain conditions. These are a result of the production process and cannot be avoided. They constitute therefore is no reason for claim.

7. INSULATING GLASS UNITS

Normative references	
ÖNORM EN 1279-1	Glass in building – Insulating glass units Part 1: Generalities, dimensional tolerances and rules for the system description
ISO 11479-2	Glass in building – Coated glass Part 2: Colour of facade

7.1. Dimensional tolerances

7.1.1. Dimensional tolerances/offset tolerances

When insulating glass unit dimensions are quoted for rectangular panes, the first dimension shall be the width, B, and the second dimension the height, H, as shown in Picture 26. It shall be made clear which dimension is the width B, and which is the height H, when related to its installed position.

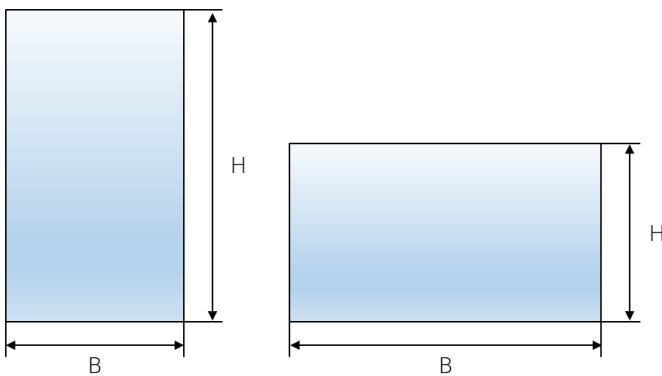

Picture 26: examples of width and height relative to the pane shape

Characteristics of the IGU	Tolerances for B and H	Offset
All panes ≤ 6 mm and (B and H) ≤ 2000 mm	± 2 mm	≤ 2 mm
6 mm < thickest pane ≤ 12 mm or 2000 mm < (B or H) ≤ 3500 mm	± 3 mm	≤ 3 mm
Thickest pane ≤ 12 mm and 3500 mm < (B or H) ≤ 5000 mm	± 4 mm	≤ 4 mm
1 pane > 12 mm and (B or H) > 5000 mm	± 5 mm	≤ 5 mm

Table 27: dimensional tolerances for double or triple glazed IGUs according to ÖNORM EN 1279-1

7.1.2. Distortion on the glass edge

The distortion on the glass edge must not exceed 3 mm per 1000 mm glass edge length.

When using tempered glasses with square or almost square formats (up to 1:1,5) and single panes with a nominal thickness of less than 6 mm, a greater distortion is allowed.

7.1.3. Thickness tolerance along the periphery of the unit

The actual thickness shall be measured between the outside glass surfaces of the unit, at each corner and at the approximate centre points of the edges. The values shall be measured to the nearest 0.1 mm. The measured thicknesses shall not vary from the nominal thickness given by the manufacturer of the insulating glass units by more than the tolerances shown in Table 28.

Type of IGU	Types of monolithic glasses	Thickness tolerance
Double glazing	annealed float glass only	± 1.0 mm
	At least one pane is made of laminated glass, ornament glass or thermally toughened.	± 1.5 mm
Triple glazing	annealed float glass only	± 1.4 mm
	At least one pane is made of laminated glass, ornament glass or thermally toughened.	+ 2.8 mm/- 1.4 mm

Table 28: thickness tolerances of insulating glass units according to ÖNORM EN 1279-1

These tolerances are only valid for IGUs containing 2-sheet laminated glasses. For IGU with 3-sheet (or more) laminated glass, the tolerances given in Table 29 apply.

Type of IGU	Thickness tolerance
Double glazing	± 2.0 mm
Triple glazing	± 3.4 mm

Table 29: thickness tolerances of IGUs with 3-sheet (or more) laminated glass (Eckelt Standard)

7.1.4. Position of the spacer/Edge seal

	Tolerance
Position of the spacer relative to the glass edge	± 2,0 mm

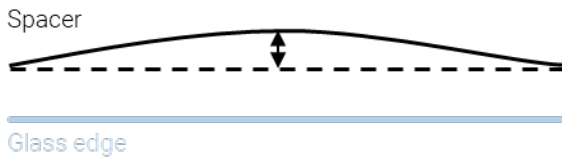

Picture 27: spacer position relative to the glass edge

Note: At the time of the delivery the sealant or adhesive compound may not encroach more than 2 mm beyond the edge seal and into the cavity or onto the glass.

In corners and spacer-connecting locations as well as when using special glasses (e.g. cast glass), the intrusion of either the seal or the adhesive compound into the cavity or onto the inner glass surface can not be avoided. This is due to technical reasons and is no ground for claims.

7.2. Visual quality

The requirements for the optical and visual quality of the different glass components must comply with the previously defined criteria.

The Table 30 to Table 32 give the maximum number of permissible defects per insulating glass units. These tables shall not be applied to IGUs where at least one component is an ornamental glass, wired glass, wired ornamental glass, drawn flat glass or fire-resistant laminated glass.

7.2.1. Conditions of inspection

The insulating glass unit must be inspected by looking at the background and not directly at the surface of the glass.

The defects must not be marked before the inspection.

The glass must be inspected from a distance of at least 3 meters from the inside to the outside for a period of up to 1 minute per square meter and at a viewing angle as perpendicular as possible to the glass surface. The inspection is performed during diffuse daylight (e.g. overcast sky) without direct sunlight or artificial lighting.

Insulating glass units that have to be inspected from the outside to the inside must be inspected in installed conditions (or similar), taking into account the usual viewing distance. The minimum distance of 3 meters must be maintained and the viewing angle has to be as perpendicular as possible to the glass surface.

Defects smaller than 0.5 mm will not be taken into account.

The Picture 28 shows the different areas of observation.

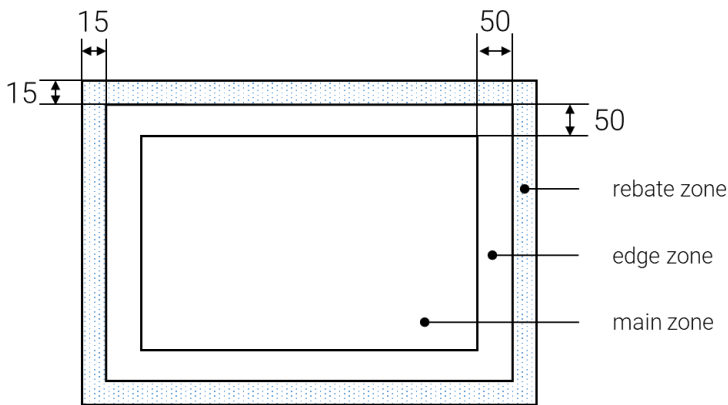

Picture 28: zones for the assessment of visual quality according to ÖNORM EN 1279-1 (dimensions in mm)

Note: If no cut-back is carried out on glasses with acute angles, the surface of the possible cut-back will not be assessed. In this zone irregularities or break-offs may occur at the edges as well as on the surface. These are no reason for claims.

7.2.2. Acceptance criterias for defects

7.2.2.1. Double glazed insulating glass units made of two monolithic glass panes

Note: For IGUs with post-tempered coatings, 2 defects with a maximum diameter of 3 mm per square meter are allowed in the main zone, in addition to the permissible defects given in Table 30 to Table 32.

7.2.2.1.1. Point-formed defects

Zone	Size of the defect without halo (mm)	Surface of the glass S (m ²)			
		$S \leq 1$	$1 < S \leq 2$	$2 < S \leq 3$	$S > 3$
Rebate zone	all	no restriction			
Edge zone	$\varnothing \leq 1$	permissible if less than 3 defects within a circular area of 20 mm diameter			
	$1 < \varnothing \leq 3$	4	1 per linear m edge length		
	$\varnothing > 3$	not permissible			
Main zone	$\varnothing \leq 1$	permissible if less than 3 defects within a circular area of 20 mm diameter			
	$1 < \varnothing \leq 2$	2	3	5	5 + 2 per additional m ² above 3 m ²
	$\varnothing > 2$	not permissible			

Table 30: permissible number of point-formed defects according to ÖNORM EN 1279-1

Note: Minor desiccant residues in the cavity cannot be ruled out and do not constitute a reason for claim.

7.2.2.1.2. Residues

Zone	Type and size of the defect (mm)	Surface of the glass S (m ²)	
		$S \leq 1$	$S > 1$
Rebate zone	all	no restriction	
Edge zone	points with $\varnothing \leq 1$	no restriction	
	points with $1 < \varnothing \leq 3$	4	1 per linear m edge length
	stains with $\varnothing \leq 17$	1	
	points with $\varnothing > 3$ and stains with $\varnothing > 17$	1	
Main zone	points with $\varnothing \leq 1$	permissible if less than 3 defects within a circular area of 20 mm diameter	
	points with $1 < \varnothing \leq 3$	permissible if less than 2 defects within a circular area of 20 mm diameter	
	points with $\varnothing > 3$ and stains with $\varnothing > 17$	not permissible	

Table 31: permissible number of residues (points and stains) according to ÖNORM EN 1279-1

7.2.2.1.3. Linear defects

Zone	Individual length (mm)	Sum of the individual lengths (mm)
Rebate zone	no restriction	
Edge zone	≤ 30	≤ 90
Main zone	≤ 15	≤ 45

Table 32: permissible length of linear/elongated defects according to ÖNORM EN 1279-1

Note: Hairline scratches are allowed as long as they do not form a cluster. A hairline scratch is a fine scratch that cannot be felt with the fingernail and that can only be seen with a direct incident light.

7.2.2.2. Insulating glass units made of more than two monolithic glass panes

The numbers of permissible defects given in Table 30 to Table 32 are increased by 25% for every additional glass component (in the case of triple glazed IGU, or IGU with laminated glasses). The number of defects is always rounded up to the next whole number.

Example: Triple glazed IGU made of 3 monolithic glass panes: the number of permissible defects will be multiplied by 1.25.

Double glazed IGU made of 2 laminated glasses each containing 2 monolithic glasses (4 monolithic glasses in total): the number of permissible defects will be multiplied by 1.5.

7.2.2.3. Edge defects

Edge defects allowable for each glass sheet are specified in the previous sections.

External shallow damages to the edge or shells which do not affect the glass strength and do not extend beyond the width of the edge sealant are acceptable.

Internal shells without loose shards which are filled by the sealant are acceptable.

7.3. Process and product features

7.3.1. Edge deletion

Depending on its type, the coating may be removed by grinding in the edge seal area. As a result, some grinding traces may be visible, and the deleted area may differ from the rest of the glass. This also applies to the glass overhang in stepped IGUs.

In the case of insulating glass units with a combination of tempered glasses and post-tempered coating, coating residues may appear on the outside of the insulating glass. These residues are caused by our suppliers during the coating process and cannot be avoided. They will corrode and weather-off by themselves after some time.

7.3.2. Edge deletion with silicon coating or printing

Extra-wide edge deletion is carried out in several steps. A grinding wheel will remove successive coating layers until the desired edge deletion width is achieved.

If the edge deletion area is printed or coated with silicon, grinding marks and inhomogeneities will be visible. These do not constitute a reason for claim.

In case of high aesthetic requirement where a homogenous appearance of wide steps or edge seals is necessary, Eckelt recommends covering the edge deletion with a screen-printing.

7.3.3. Visual effect of colour-lines & white-lines

During the production of insulating glasses units, an edge deletion is carried out to remove functional Low-E coatings before the individual panes are assembled. This edge deletion primarily serves to improve the adhesion of the secondary sealant (polysulfide, silicone) to the glass and thus ensure the mechanical properties of the insulating glass unit.



When the primary sealant (butyl) meets the coating, a coloured line becomes visible in reflection. Its colour depends on the low-e coating used (red, blue, green, etc.).

If the edge deletion is wider than the edge seal, a narrow light stripe, called white-line, occurs between the butyl edge and the functional coating. It might be more or less visible depending on the contrast with the coating.

These effects are only visible on unframed insulating glass units (e.g. SSG) and represent a product characteristic.

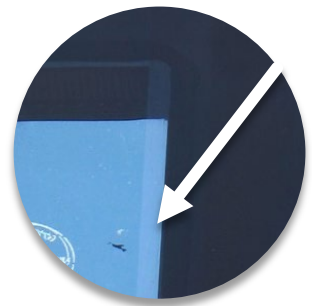

7.3.4. Evaluation of the visible area of the edge seal

If the insulating glass edge seal is not covered by a frame on one or more sides, production-related features can be visible in the area of the edge seal (primary and secondary sealant as well as spacers), thus outside the clear glass area, e.g.:

- Dirt, bubbles, blowholes
- Inhomogeneities in the edge seal
- Color difference between the primary and secondary sealant
- Sides of the spacer visible
- Spacer joints and butyl extrusion at joints
- Different spacer bending radii
- Spacer markings
- Pressure equalization holes in the spacer or system for pressure equalization

These features will be more visible with not-black sealants (e.g. grey butyl, grey silicone) and light-coloured spacers.

Sealant presence on the glass edges or on parts integrated on the edge seal cannot be avoided for production technical reasons and do not constitute a reason for a claim.

7.3.5. Spacer bar

Bent and joined spacer bar systems, may have different appearances depending on the production process and the materials properties. Gas-filling holes may also be visible in the spacer bar. The colour of the spacer will influence the behavior of reflections at the edge of the unit.

7.3.6. Marking of the spacer bar

The position and number of markings are determined by the machine and can not be influenced. A lack or a deviation (color, size, text, etc.) of the marking does not constitute a reason for a claim.

7.3.7. Insulating glass units with steps or extra-wide edge seal

For aesthetic reasons it is often necessary to make the edges of the glass units homogeneous and opaque, to conceal fastening elements of the substructure for example.

This opaque layer can be achieved either by enamelling or covering the glass edges with silicone.

In case of silicon coating, more sealant is applied by the machine. The excess is then spread manually over the surface using a spatula. This produces a completely opaque and robust silicone layer which can be used, for example, as an adhesive primer for load-bearing bonding.

It should be taken into account that neither the 2-component sealants nor the dosing and mixing equipment have been developed for decorative coatings with a completely homogeneous appearance. Narrow glass steps or joint widths will normally be homogenous while broader surfaces may appear a little cloudy. This inhomogeneity is technically acceptable since the two sealant components are mixed together as well as possible. The sealant will cure well and the physical as well as chemical properties will be achieved durably.

7.3.8. Butyl entry into the IGU cavity

Butyl penetration in the IGU cavity usually occurs some time after the glazing.

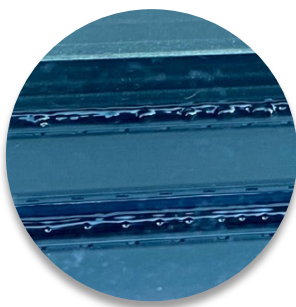

Causes for this phenomenon can be:

- High temperature in the rebate zone
- Too much and/or uneven pressure on the edge seal of the insulating glass unit.

Provided that there is no incompatibility between the glazing materials and the sealants used in the IGU, the butyl penetration is purely a visual feature and does not affect the durability of the insulating glass unit when installed.

7.3.9. Silicone bleeding

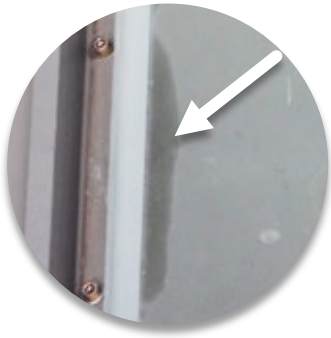

In case of high temperatures and/or high pressure on the silicone joint, silicone oils may escape leaving an oily or wet appearance on satinized or sandblasted surfaces. Eckelt recommend shortening the cleaning interval for the types of glasses mentioned.

7.3.10. Interference patterns

Interference patterns in the form of spectral colours may occur in insulating glass units made of float glass. Optical interferences are due to the superposition of two or more light waves at a single point.

They appear as more or less intensively coloured zones which change when pressure is applied to the glass. This physical effect is reinforced by the plane parallelism of the glass surfaces. Interferences occur randomly and cannot be influenced.



7.3.11. Multiple reflections

Multiple reflections of varying intensity can occur on the glass surfaces. These reflections can appear more pronounced if for example the background of the glazing is dark. This phenomenon is a physical property of every insulating glass unit.

7.3.12. Specific effects due to barometric conditions

Insulating glass units are characterized by an air/gas volume enclosed by the edge seal. The state of the gas is mainly determined by the barometric air pressure, the altitude above mean sea level (m.s.l.) and the air temperature at the time and place of production. Installing an insulating glass at other altitudes, with temperature variations and fluctuations in the barometric air pressure (high or low pressure), inevitably induces concave or convex bulging of the individual panes and therefore optical distortions.

7.3.13. Sealant compatibility



“Incompatibility” is the term used to describe the interaction between different materials of a system, which have a negative effect on the function of one or more components of the system.

This is caused by transfer of substances of different concentrations from neighbouring materials that are in direct or indirect contact with one another.

Incompatibilities can lead to visual disturbance and even system failure.

The following points should be taken in account particularly when combining sealants:

- Do not use untested combinations of materials
- Pay attention to direct (e.g. weather sealing, setting blocks) and indirect components (e.g. adhesive for setting block fixing)
- Compatibility tests are only snapshots and should be done with the batches of materials used
- Joint dimensioning and maximum joint depths for single-component sealing materials must be respected.

8. SSG – BONDING TOLERANCES AND TOLERANCES FOR THE INTEGRATION OF FITTINGS

Normative references

ÖNORM EN 13022	Glass in building – Structural sealant glazing
----------------	--

8.1. Thickness tolerance

In addition to the thickness tolerances of the pre-products a bonding tolerance of ± 2 mm applies for SSG.

8.2. Bonding tolerances

Note: For monolithic glass and LSG, the prerequisite is always a ground or polished edge. For insulating glass unit, the prerequisite is that the outer pane always has a ground or polished edge.

8.2.1. SSG bonding with monolithic glasses or with IGU made of monolithic glasses

8.2.1.1. Rectangles

Edge length	Bonding tolerance
≤ 2000 mm	± 2.0 mm
≤ 4000 mm	± 3.5 mm
> 4000 mm	± 5.0 mm

Table 33: bonding tolerances for rectangles monolithic glasses or IGU made of monolithic glasses

8.2.1.2. Shapes and bent glasses

Edge length	Bonding tolerance
≤ 2000 mm	± 4.0 mm
≤ 4000 mm	± 5.5 mm
> 4000 mm	± 7.0 mm

Table 34: bonding tolerances for shapes and bent monolithic glasses or IGU made of monolithic glasses

8.2.2. SSG bonding with laminated glass

8.2.2.1. Rectangles

Edge length	Bonding tolerance
≤ 2000 mm	± 3.0 mm
≤ 4000 mm	± 4.5 mm
> 4000 mm	± 6.0 mm

Table 35: bonding tolerances for rectangle with laminated glass

8.2.2.2. Shapes and bent glasses

Edge length	Bonding tolerance
≤ 2000 mm	± 5.0 mm
≤ 4000 mm	± 6.5 mm
> 4000 mm	± 8.0 mm

Table 36: bonding tolerances for shapes and bend glazing with laminated glass

8.3. Application of fittings

For ironmongery and fittings that are to be fixed into countersunk holes, the tolerances given in the chapter 3.2.7.1.2 Countersunk holes are applicable.

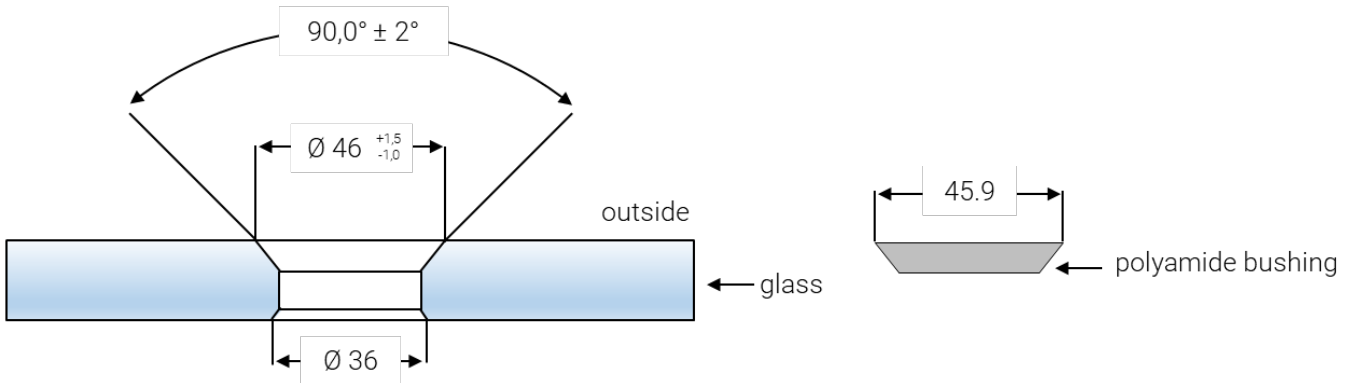

countersunk hole nominal dimensions and tolerances

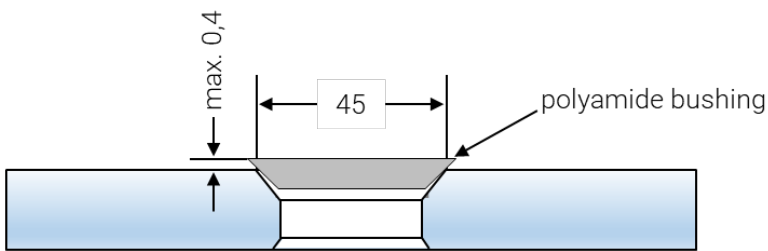

if the mind. tolerance is -1 mm

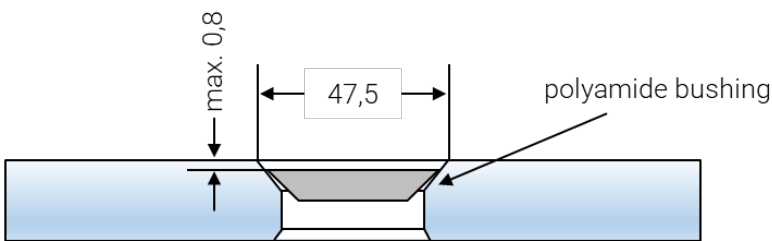

if the max. tolerance is +1,5 mm

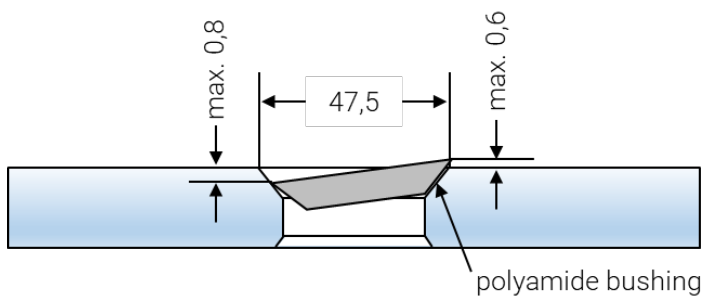

Picture 29: schematic representation of possible mounting positions of e.g. MULTI-POINT fittings, 90° countersunk (Dimensions in mm)

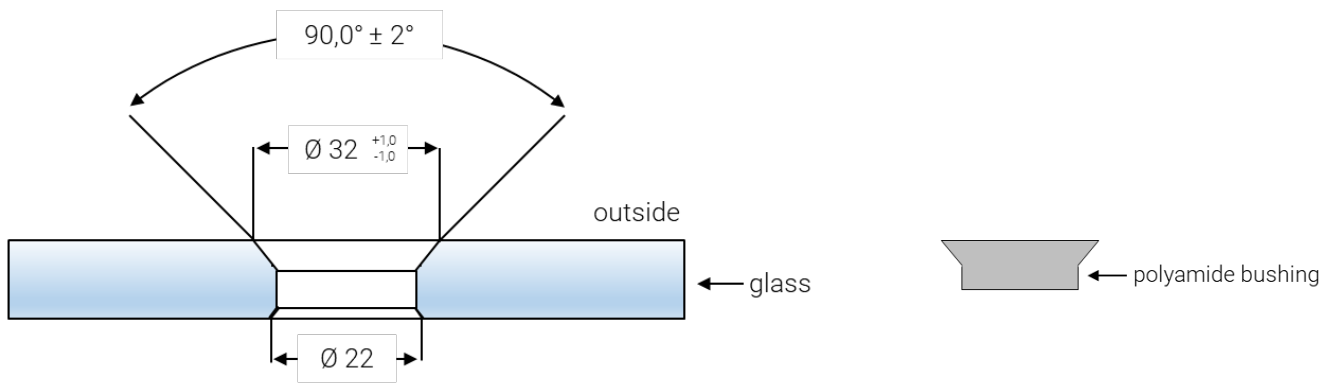

countersunk hole nominal dimensions and tolerances

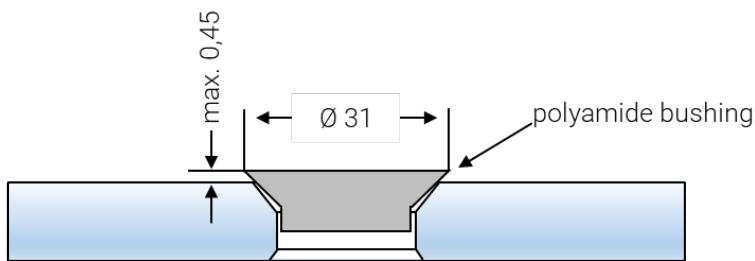

if the mind. tolerance is -1 mm

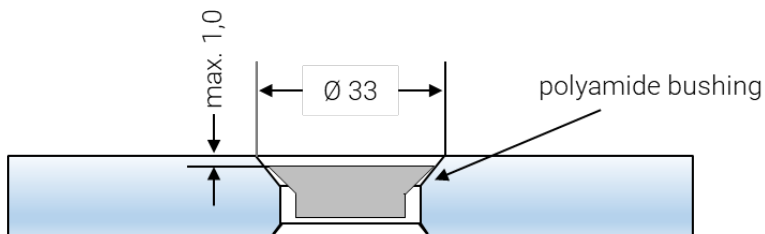

if the max. tolerance is +1 mm

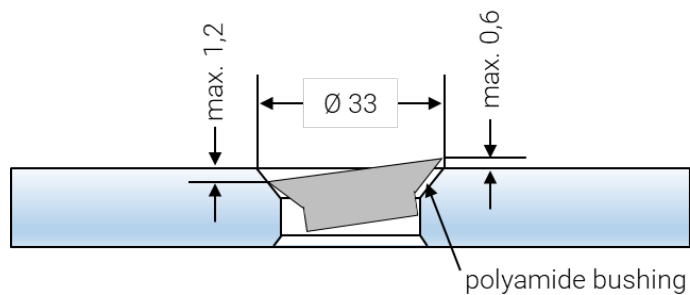

Picture 30: schematic representation of possible mounting positions of e.g. LITE-WALL fittings, 90° countersunk (dimensions in mm)

9. DLS ECKLITE®

The assessment of the visual quality of DLS ECKLITE® is carried out according to the guideline of the Bundesverband Flachglas:

BF-Bulletin 007 /2010-Modification index 1 1 – July 2018

Guideline to assess the visual quality of systems in insulating glass units.

The dimensional tolerances are given in the chapter [Insulating glass units – 7.1. dimensional tolerances.](#)

10.VARIO®

10.1. Definition

VARIO® is an insulating glass designed for the transom-mullion system FW50 SG from the company Schüco, without cover plates.

There are different types of VARIO®:

- VARIO® DZ: this type is manufactured with VARIO® connectors and mechanical retaining devices on all four sides.
- VARIO® S-FOR: this type is manufactured with 4 VARIO® connectors and mechanical retaining devices. All other VARIO® connectors are without mechanical restraints.
- VARIO® II: this type is manufactured with VARIO® connectors without mechanical retaining device. When mechanical retaining devices are omitted, the responsibility for approval lies with the customer.

10.2. Tolerances

10.2.1. Glass segment cutting ("kerf")

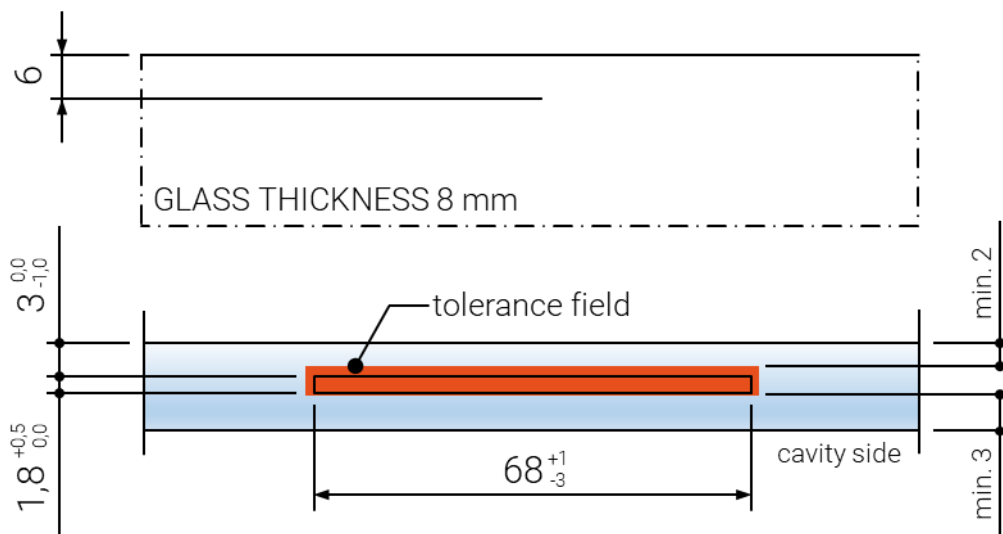

Picture 31: tolerances of the segment cutting for a glass thickness of 8 mm (dimensions in mm)

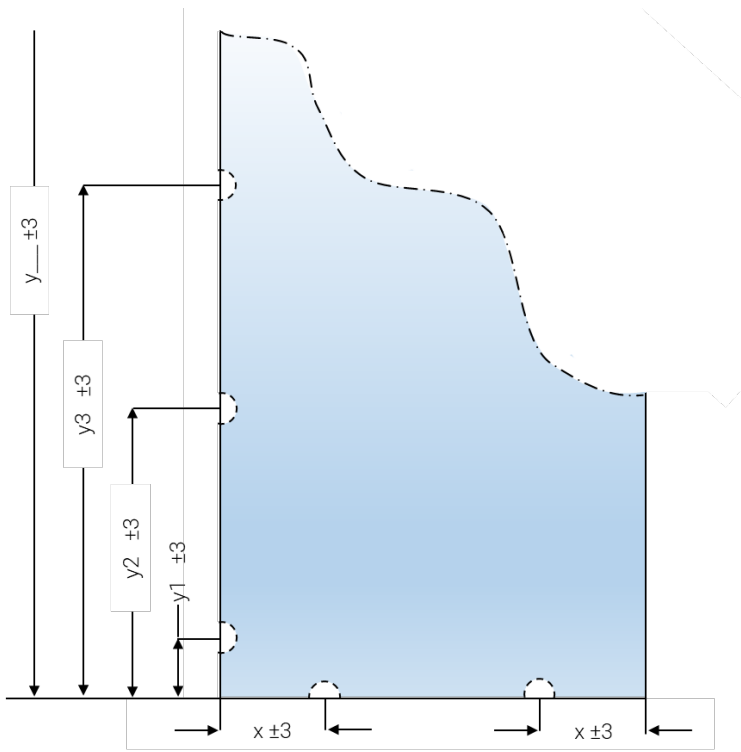

Picture 34: Position tolerance of segment cutting (dimensions in mm)

10.2.3. Position of the mechanical restraining device

positioning tolerance of the mechanical restraining device	± 2 mm
--	------------

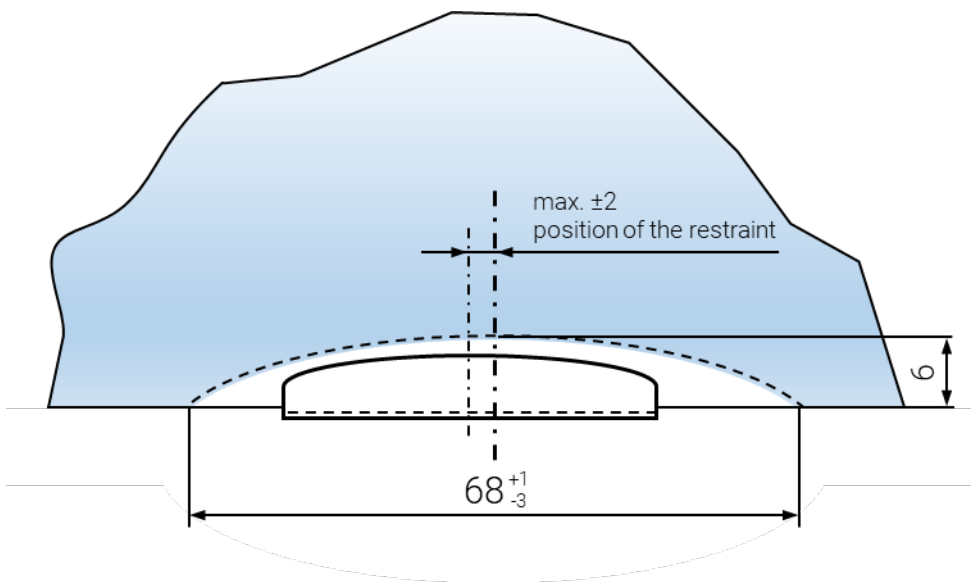

Picture 35: positioning tolerance of the mechanical restraining device (dimensions in mm)

11. GENERAL PRODUCT AND PROCESS FEATURES

11.1. Haze



In case of a multi-pane laminated glass in combination with a SentryGlas® interlayer (SG5000), a haze phenomenon (milky clouding between the panes) can occur. This is a product characteristic that cannot be avoided during the production process.

In installed conditions, environmental factors can cause glass corrosion and/or deposit (fogging) on the external surface of the glass. A clouding of the surface (haze) can be observed, especially when there is a strong direct light incidence on the glass surface. This effect can hardly be removed through cleaning.

Compared to clear glass, coated products can present a certain degree of haze due to the low roughness of their surface. It can become visible depending on the intensity and incidence of the light and the viewing angle.

The aforementioned effects are physical and chemical product characteristics which do not constitute a reason for claim.

11.2. Colour differences

The human eye reacts to different colours in very different ways. While a minor colour difference in blue shades is easily noticeable, colour differences in green shades will be perceived less clearly.

An objective visual estimation and assessment of colour differences is not possible. The introduction of an objective evaluation standard is therefore necessary. Eckelt uses the CIELAB method to measure the colour differences.

additional notes	
VFF Merkblatt V.03	Colour uniformity of transparent glasses in the building industry (german only)
Glass for Europe	Code of Practice for in-situ measurement and evaluation of the color of coated glass used in facades

11.2.1. Colour differences in basic glass

The raw materials required for basic glass never have the exact same composition. This, in relation with the variation in iron oxide content, results in a variation of the glass colour.



The slightly greenish refraction of basic glass is due to the chemical additives in the glass melt. Its intensity increases with the glass thickness, but it can also change during production over longer periods of time. Glasses of different production batches may as well have different coloration.

These color differences are a product characteristic and do not constitute a ground for claim.

11.2.2. Colour differences in coated glass

In addition to the color differences in the basic glass, production and batch-related colour variations in transmission and reflection can also occur in coatings.

Different light sources, lighting conditions, ambient reflections and especially the viewing angle lead to color difference during the observation. These colour variations and changes in appearance depend on the coating type.



additional notes	
ISO 11479-2	Glass in Building - Coated Glass Part 2: Color of facade
Glass for Europe	Code of Practice for in-situ measurement and evaluation of the color of coated glass used in facades

11.2.3. Colour differences in enameled/printed glasses

See chapter [4.2.4. Assessment of the colour impression](#).

11.3. Wettability of glass surfaces

The wettability of the glass surface is affected by the contact with materials used during the manufacturing process (e.g. transport rolls, labels, suction cups, sealant residues, silicone vapors), during the assembly or installation (fingerprints, smoothing agents) as well as by environmental factor and subsequent use (application of stickers and film).

When the glass surface is wet or fogged up because of condensation, rain, cleaning water as well as fogging – i.e. due to the evaporation (VOC emission) of substances from plastics, leather, etc. – the differences in wettability can become visible.

Such phenomenon is a characteristic feature of glass and is no reason for claim.

11.4. Condensation on glass surfaces

If air saturated with humidity enters in contact with a cold glass pane, it cools down and releases some of the water it contains onto the glass surface. This water condenses, fogging up the pane and thus limiting the view.

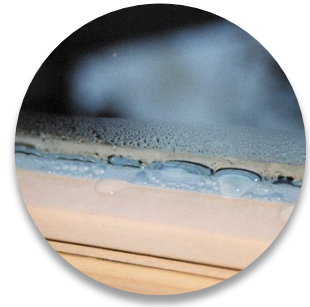

For old single glazing, this effect occurs mostly on the inside, whereas more effective thermal insulating glazings fog up more often on the outside. This is not a defect but a physically justified and positive sign: the better the thermal insulation of the IGU (lower heat transfer from the inside to the outside or low U_g -value) the colder the outside glass surface and the higher the potential for condensation. Especially early in the morning and in areas with high humidity, condensation occurs on the glass surface. It can also freeze in case of negative temperatures. This physical phenomenon is no reason for a claim.

11.5. Subsequent processing of the glasses

A subsequent processing of the glass, regardless of its type, may significantly affect the properties of the product and is therefore prohibited and will void any warranty.

11.6. Subsequently applied films

Subsequent application of films (e.g. advertising, decoration, visual protection, splinter protection, bird protection, etc.) on the glass surface may affect the properties of the glass. Depending on the product used it can decrease the performances and safety properties of the glass as follow:

- Increased thermal load, leading to glass breakage
- Chemical incompatibility with the sealant used in an insulating glass or the interlayer used in a laminated glass
- Change in the breaking patter of a safety glass, normally designed to protect the physical integrity of persons.

Claims on this matter will not be accepted and Eckelt declines all responsibility for any problem or damage arising from it.

11.7. Coating over-run for external/fixed-sized coatings

External or fixed-sized coatings are multi-layer coatings applied with a magnetron sputtering process.

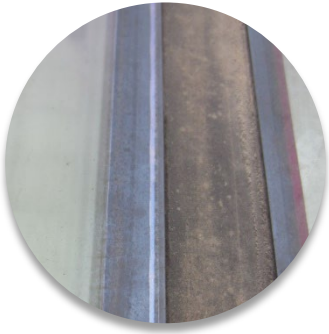

Due to the process, a coating over-run may occur on the front and bottom edges of the glass. It normally corrodes and washes off within a few months due to air humidity. As a result, enameled glasses can be visually impaired. This over-run is process related and does not constitute a reason for claim.

In case of bonded construction or SSG application this coating residue must be removed. A tape coverage of the front edge must be explicitly ordered if necessary and must be confirmed by Eckelt.

For quality reasons, the coating is always applied on the air side of the basic glass. However, since the screen printing or enamel is usually applied on the air side, the coating must in this case be applied on the tin side. Due to sulfate residues, the color may appear inhomogeneous. This effect cannot be avoided and is not a reason for claim.

11.8. Light incidence at the edge of the glass

In case of strong incident light on the front side of the glass edge, the subjective colour perception in the edge area changes. This is due to the strong difference in brightness of the affected glass surfaces. Printed glass is particularly affected since the colour background reflects the incident light more intensively.

These colour differences are more irregular for glasses with cut or arrissed edges as for glasses with ground edges.

11.9. Recommendation on the maximum temperatures of use

Material	Temperature
PVB-interlayer	- 40°C to 60°C lasting temperature, short-term max. 80°C
Butyl	- 40°C to 80°C
Polysulfide	- 40°C to 80°C
Silicone	- 50°C to 150°C

Table 37: recommendation on maximum temperatures of use

12.Example

12.1. Triple glazing IGU with laminated glass

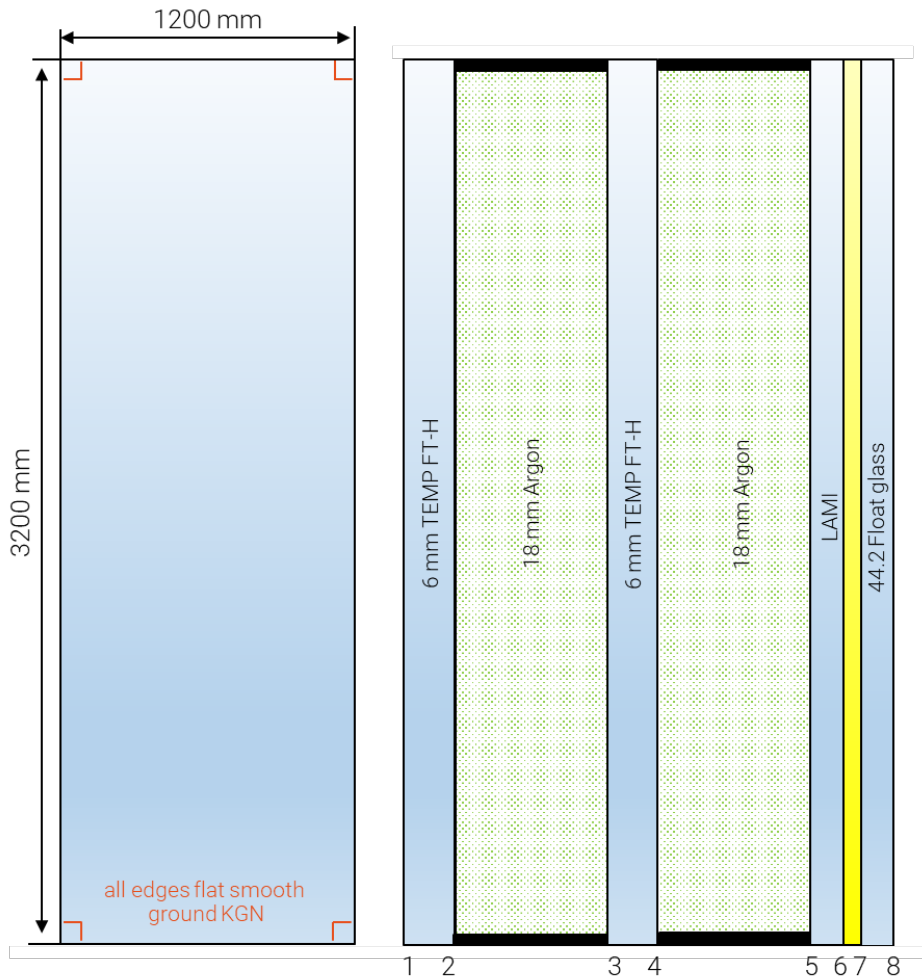

	Nominal value	Tolerance	Source	Comment
Width	1200 mm	± 3 mm	Table 27	
Length	3200 mm	± 3 mm	Table 27	
Offset		3 mm	Table 27	
Thickness	54.76 mm	+2.8/-1.4 mm	Table 28	
Rollerwave distortion		0,3 mm/300 mm		
Overall bow		9.6 mm		3 mm per 1000 mm edge length
Position of the spacer		± 2 mm		

12.2. 3-sheet laminated glass

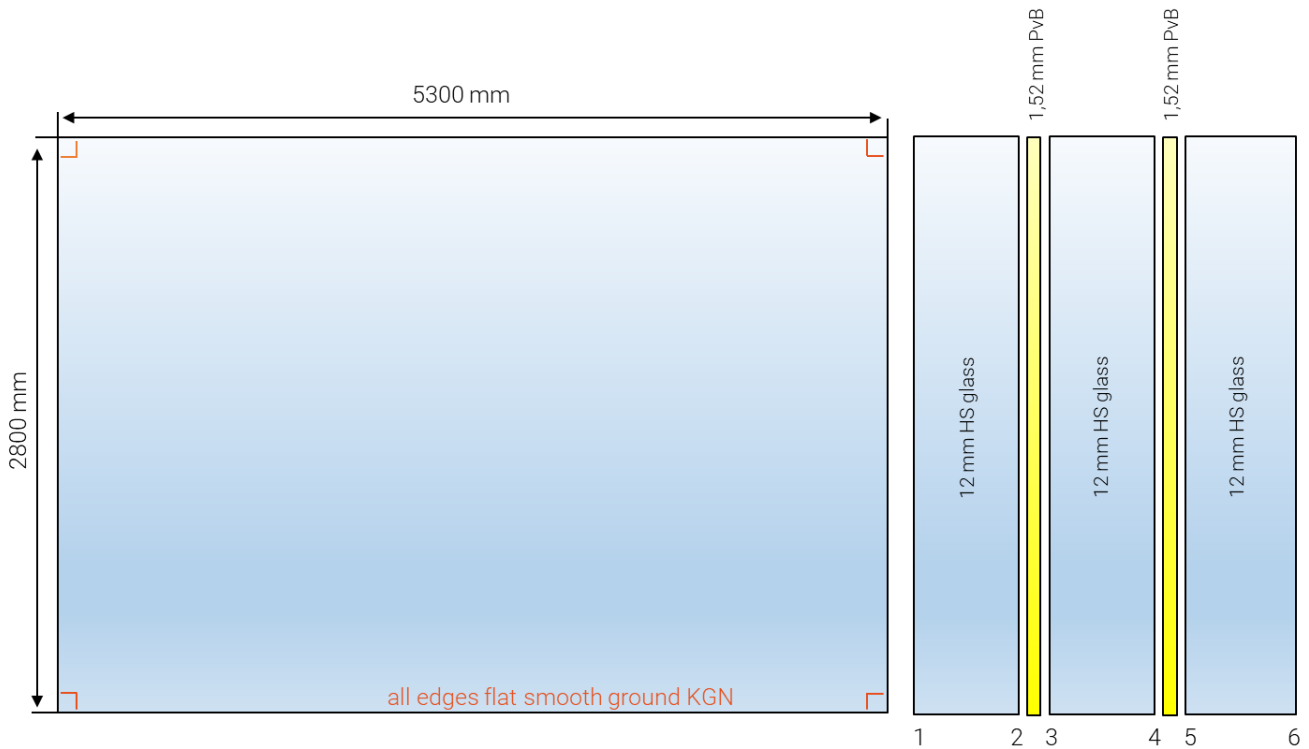

	Nominal value	Tolerance	Source	Comment
Width	5300 mm	+ 10/-8 mm	Table 20	additional ± 3 mm for HS glasses
Length	2800 mm	+ 9/-7 mm	Table 20	additional ± 3 mm for HS glasses
Offset			Chapter 6.1.3	to be agreed with the manufacturer
Thickness	39.04	1.1 mm	Table 1 + Chapter 6.1.4	
Diagonale		13 mm	Table 21	
Rollerwave distortion		0.3 mm/300 mm		
Overall bow		17.5 mm		3 mm per 1000 mm edge length

13.LIST OF TABLES

Table 1: thickness tolerances for float glass according to ÖNORM EN 572-2.....	6
Table 2: thickness tolerances for float glass according to ÖNORM EN 572-5.....	6
Table 3: tolerance of slope-cut (Eckelt Standard).....	8
Table 4: permissible number of point-formed defects (following the ÖNORM EN 1279-1).....	10
Table 5: permissible number of residues (points and stains) following the ÖNORM EN 1279-1.....	10
Table 6: permissible length of linear/elongated defects (following the ÖNORM EN 1279-1).....	11
Table 7: length of the cut-back (Eckelt Standard).....	11
Table 8: length and width tolerance for ground or polished edges (Eckelt Standard).....	15
Table 9: tolerances of cut-outs (Eckelt Standard).....	17
Table 10: tolerance of cylindrical holes (Eckelt Standard).....	17
Table 11: core diameter tolerances for countersunk holes (Eckelt Standard).....	18
Table 12: tolerances of countersunk holes (Eckelt Standard).....	18
Table 13: position tolerances for holes (Eckelt Standard).....	18
Table 14: restrictions on the position of a borehole (Eckelt Standard).....	21
Table 15: dimensional tolerances for enamel and screen-printing (according to BF-Bulletin 015).....	22
Table 16: visual quality of enameled glass.....	24
Table 17: tempered products.....	31
Table 18: tolerances for the overall bow and rollerwave distortion (Eckelt Standard).....	32
Table 19: edge lift tolerance (Eckelt Standard).....	33
Table 20: tolerance of the height B and the length H for LSG according to ÖNORM EN ISO 12543-5.....	36
Table 21: maximum allowed difference between the diagonals of a LSG according to ÖNORM EN ISO 12543-5.....	36
Table 22: maximum permissible offset d according to ÖNORM EN ISO 12543-5.....	37
Table 23: edge area according to ÖNORM EN ISO 12543-6.....	39
Table 24: acceptance criteria for defects in LSG according to ÖNORM EN ISO 12543-6.....	40
Table 25: allowable number of point-formed defects (1.0 mm < d ≤ 3.0 mm) in the vision area acc. to ÖNORM EN ISO 12543-6.....	40
Table 26: allowable number of linear defects in the vision area according to ÖNORM EN ISO 12543-6.....	41
Table 27: dimensional tolerances for double or triple glazed IGUs according to ÖNORM EN 1279-1.....	44
Table 28: thickness tolerances of insulating glass units according to ÖNORM EN 1279-1.....	45
Table 29: thickness tolerances of IGUs with 3-sheet (or more) laminated glass (Eckelt Standard).....	45
Table 30: permissible number of point-formed defects according to ÖNORM EN 1279-1.....	47
Table 31: permissible number of residues (points and stains) according to ÖNORM EN 1279-1.....	48
Table 32: permissible length of linear/elongated defects according to ÖNORM EN 1279-1.....	48
Table 33: bonding tolerances for rectangles monolithic glasses or IGU made of monolithic glasses.....	54
Table 34: bonding tolerances for shapes and bent monolithic glasses or IGU made of monolithic glasses.....	54
Table 35: bonding tolerances for rectangle with laminated glass.....	55
Table 36: bonding tolerances for shapes and bend glazing with laminated glass.....	55
Table 37: recommendation on maximum temperatures of use.....	65

14.LIST OF PICTURES

Picture 1: representation of the tolerances	Picture 2: representation of the height and width	7
Picture 3: under-length		8
Picture 4: over-length.....		8
Picture 5: diagonal tolerance.....		8
Picture 6: zones for the assessment of visual quality (dimensions in mm)		9
Picture 7: cut-back.....		11
Picture 8: shells.....		15
Picture 9: chamfer tolerance for edge machining (Eckelt Standard)		16
Picture 10: beveled edge.....		16
Picture 11: corner cut-off.....		16
Picture 12: different types of cut-outs.....		17
Picture 13: cylindrical holes.....		17
Picture 14: countersunk hole.....		18
Picture 15: examples for the position of holes based on a reference point.....		19
Picture 16: dubbed corner.....		19
Picture 17: position of the holes		21
Picture 18: position and design tolerances of printed glass		22
Picture 19: representation of the overall bow and the roller wave distortion		31
Picture 20: support conditions for the measurement of overall bow		32
Picture 21: area for the measurement of the edge lift		32
Picture 22: measurement of the edge lift		33
Picture 23: shift tolerances for laminated safety glass.....		37
Picture 24: countersunk holes in laminated glass		38
Picture 25: edge and vision area for laminated glasses according to ÖNORM EN ISO 12543-6.....		39
Picture 26: examples of width and height relative to the pane shape.....		44
Picture 27: spacer position relative to the glass edge.....		46
Picture 28: zones for the assessment of visual quality according to ÖNORM EN 1279-1 (dimensions in mm)		47
Picture 29: schematic representation of possible mounting positions of e.g. MULTI-POINT fittings, 90° countersunk (Dimensions in mm)		56
Picture 30: schematic representation of possible mounting positions of e.g. LITE-WALL fittings, 90° countersunk (dimensions in mm)		57
Picture 31: tolerances of the segment cutting for a glass thickness of 8 mm (dimensions in mm)		59
Picture 32: tolerances of the segment cutting for a glass thickness of 10 mm (dimensions in mm).....		60
Picture 33: tolerances of the segment cutting for a glass thickness of 12 mm (dimensions in mm).....		60
Picture 34: Position tolerance of segment cutting (dimensions in mm)		61
Picture 35: positioning tolerance of the mechanical restraining device (dimensions in mm).....		61